



# Occupancy/Vacancy Sensor

Design and Application Guide



## Occupancy/Vacancy Sensor Design and Application Guide

- 02** Benefits
- 03** Codes and standards
- 04** Technologies
- 06** Occupancy vs. vacancy sensors
- 07** Wired vs. wireless
- 08** Sensor placement examples
  - 08** Open offices
  - 10** Private offices
  - 14** Restrooms
  - 22** Hallways
  - 26** Classrooms
  - 30** Conference rooms
  - 34** Warehouses
  - 38** Lecture halls
  - 40** Gymnasiums
  - 44** Utility rooms
  - 48** Data centers
  - 50** Kitchen areas/break rooms
- 58** Sensors
- 86** Power packs
- 88** Accessories
- 90** Compatible products

Occupancy/vacancy sensors, which can automatically turn lights on when you enter a room and off when you leave, are a smart and easy way to save energy in commercial applications.

According to the U.S. Department of Energy, lighting accounts for an average of 38 percent of electricity used in commercial buildings—more than any other building system. Utilizing occupancy/vacancy sensors is a key strategy for saving lighting energy. In fact, Lutron occupancy sensors can typically save 30 percent—and up to 60 percent—of lighting energy in a building.

### Annual electricity use in commercial buildings<sup>1</sup>

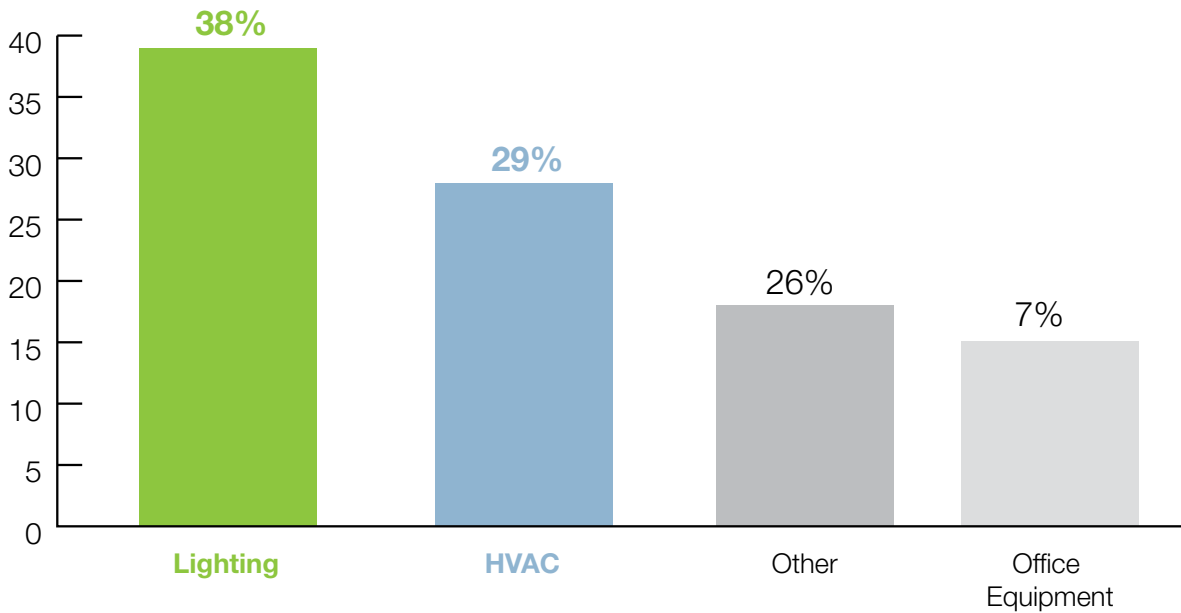

<sup>1</sup>Energy Information Administration, released September 2008. 2003 Commercial Building Energy Consumption Survey (CBECS)

<sup>2</sup>Von Nieda B, Maniccia D, & Tweed A, 2000. An analysis of the energy and cost savings potential of occupancy sensors for commercial lighting systems. Proceedings of the Illuminating Engineering Society. Paper #43.

# Occupancy/vacancy sensor benefits

## Other sensor benefits

Sensors help meet the mandatory requirements set for building construction and renovation, as well as contribute to obtaining points in several LEED credit categories (see “Meet codes and standards” on page 3.)

In addition, sensors add convenience by eliminating the need to manually turn lights on or off. And because occupancy sensors automatically turn lights on, a person never has to enter a dark room.





## Meet building energy and green codes/standards

### **ASHRAE 90.1–2010 (energy standard for commercial buildings)**

#### **Automatic Lighting Shutoff (9.4.1.1)**

All indoor lighting must include a separate automatic shut-off control, such as an occupancy sensor or time switch.

#### **Space Control (9.4.1.2b)**

An occupancy sensor, that automatically turns lighting off within 30 minutes, must be installed in classrooms, conference rooms, break rooms, storage rooms, printing rooms, private offices, restrooms, and dressing rooms.

#### **Additional Control (9.4.1.6)**

Lighting in enclosed stairwells shall have one or more control devices to automatically reduce lighting power by at least 50% within 30 minutes of all occupants leaving. And lighting in hotel guestroom bathrooms must be automatically turned off within 60 minutes of vacancy.

### **ASHRAE 189.1-2011 (high-performance green building standard)**

#### **Occupancy Sensor Controls with Multi-level Switching or Dimming (7.4.6.2)**

Requires occupancy sensors to automatically reduce lighting power by at least 50% in hotel hallways, storage and library stack areas.

### **IECC 2012 (International Energy Conservation Code)**

#### **Occupancy Sensors (405.2.2.2)**

Requires use of occupancy or vacancy sensors in classrooms, conference/meeting rooms, break rooms, private offices, restrooms, storage rooms, janitorial closets and all spaces 300 sq. ft. or less.

### **IgCC 2012 (International Green Construction Code)**

#### **Interior Light Reduction Controls (608.3)**

States that occupancy sensors must be used in corridors, enclosed stairwells, storage areas, and parking garages and must reduce the light by not less than 45%.

### **Title 24 – 2013 Part 6 (California’s energy standard)**

#### **SECTION 130.1 – INDOOR LIGHTING CONTROLS THAT SHALL BE INSTALLED**

##### **(c) Shut-off Controls**

Requires the use of occupancy sensors or other automatic shut-off devices in most spaces.

## Types of technology

Lutron sensors use different types of technology, depending on the sensor.

### Passive Infrared (PIR)

PIR technology detects a change in temperature when someone enters a room, which is how the sensor knows to turn on the lights. Sensors with this technology work best in small, enclosed spaces with high levels of occupant movement because they're engineered to detect major motion. PIR technology easily detects people walking in and out of a space.

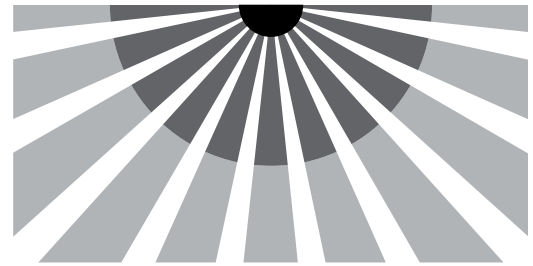

Passive infrared coverage pattern

### Ultrasonic technology

This type of technology senses when someone is in a room by bouncing ultrasonic waves off of objects in a space and detecting a frequency shift in the emitted and reflected sound waves. Ultrasonic occupancy sensors are good at detecting minor motion, such as typing, and don't require an unobstructed line of sight.



Ultrasonic coverage pattern

### Dual-technology

Dual-technology occupancy sensors use both PIR and ultrasonic technologies. Both technologies within the sensor must detect someone in a room in order to turn the lights on, but only one of the technologies needs to continually sense the person in order for the lights to stay on. Dual-technology sensors are self-adaptive to automatically adjust sensitivity and timing.

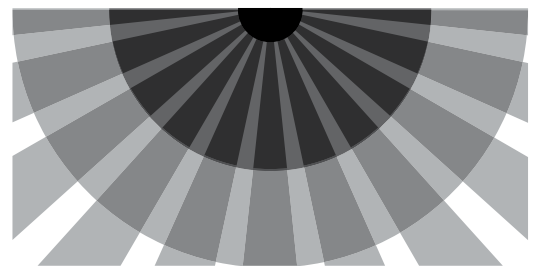

Dual-technology coverage pattern

## XCT™ technology

Lutron XCT technology recognizes the difference between fine motion, like reading a book, and background noise, better than other PIR sensors, so you aren't left in the dark.

We offer PIR sensors with XCT technology, as well as dual-technology (PIR and ultrasonic) sensors with XCT technology.

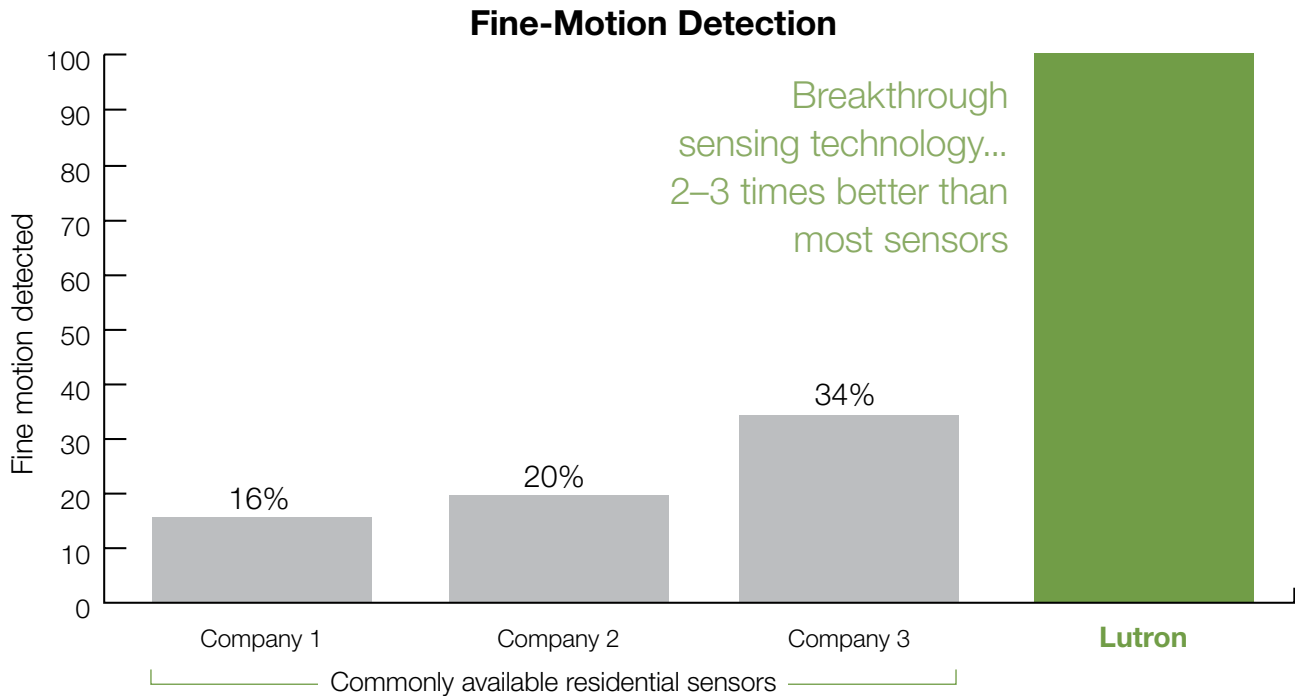

For testing methods see [www.lutron.com/sensortest638](http://www.lutron.com/sensortest638)

## Lutron technology has you covered

	<b>Major motion</b> (Person walking 3 feet)	<b>Minor motion</b> (Movements like extending your arm)	<b>Fine motion</b> (Small movements like turning book pages)	<b>Very fine motion</b> (Minimal movements such as typing)	<b>No false-on</b> (Lights stay off when room is unoccupied)
<b>PIR</b>	●				
<b>PIR with XCT</b>	●	●	●		●
<b>Ultrasonic</b>	●	●	●		
<b>Dual-technology</b>	●	●	●		●
<b>Dual-technology with XCT</b>	●	●	●	●	●

## Occupancy vs. vacancy sensors

### Occupancy sensors

An occupancy sensor automatically turns lights on when you enter a room and off when you leave, making this type of sensor the most convenient, since you never have to touch the lighting controls.

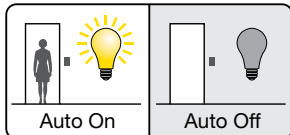

### Vacancy sensors

A vacancy sensor also turns lights off when you leave a room—but you need to manually turn them on when you walk into a room. Vacancy sensing maximizes the energy savings from the sensor because it's not always necessary to turn lights on when you walk into a room.

Many codes, such as California Energy Commission's Title 24, require vacancy, and not occupancy sensors, because occupants are less likely to turn the lights on when temporarily entering a space, or when there's sufficient daylight or hallway light.

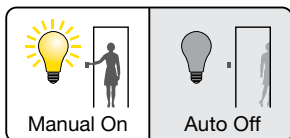

### Application examples

Occupancy/vacancy sensor		Vacancy sensor	
Commercial	Residential	Commercial	Residential
Stairwell	Bathroom	Conference room	Master bedroom
Open office	Kitchen	Private office	Child's bedroom
Private office	Laundry room		
Lobby	Hallway		
Corridors	Garage		
Break room			
Utility room			
Warehouse			

## Wired vs. wireless

Lutron's wireless occupancy/vacancy sensors are designed to make saving energy simple. Wireless sensors install in minutes and require no wiring, reducing overall costs.

### Easy to install

- No new wiring required
- Simple to install and program
- Can be easily moved if space is reconfigured

### Flexible and expandable

- Easy to mount in locations that provide maximum coverage
- Compatible with various Lutron lighting controls and systems
- Add additional sensors at any time

### Affordable

- Competitively priced
- Less material, less waste
- Lower labor and installation costs
- 10-year battery life means low maintenance costs

### Reliable

Lutron wireless occupancy/vacancy sensors are also ultra-reliable. They communicate via our proprietary Clear Connect® RF technology. Clear Connect RF technology operates on a low frequency band (434 MHz) to avoid interference from other wireless devices, ensuring superb performance.

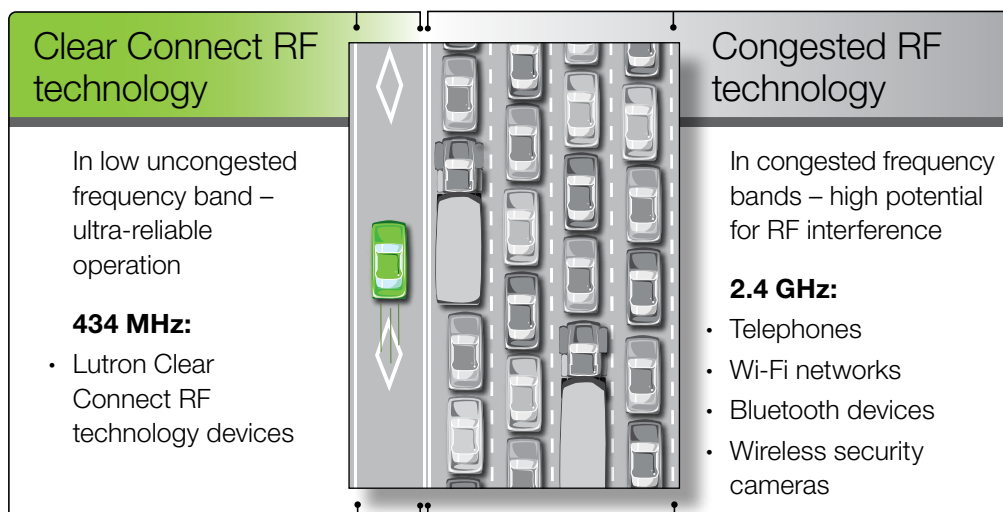



# Sensor placement examples

In this section we'll present examples of different spaces and tips to keep in mind when designing a solution for similar spaces, including the types of sensors to use and where to place them.

While this section isn't intended to design a layout for you, it should help you determine how to go about designing a layout for your specific applications.

---

## Sensor placement—open offices

Open offices are often large areas with cubical walls of varying heights, with light fixtures, air returns, sprinklers, and other devices on the ceilings—all of which you'll need to take into account. Another important thing to note is that it's not usually necessary to have occupancy sensor coverage on every square inch of space in an open office, simply because these spaces generally have many people moving around in them.

### Helpful hints

- Cover the main walkways.
- Make sure that the coverage patterns overlap on the walkways. This is important for ensuring that there aren't blind spots where people might walk around but not trigger the occupancy sensor.
- Use a longer timeout (15 or 30 minutes).
- Use ceiling-mounted sensors; if the cube walls are short you might also want to use wall-mounted sensors.
- Avoid mounting sensors close to air vents, as the vibration and air flow can reduce the effectiveness of the sensor (PIR sensors should not be within 4 ft of an air vent, and ultrasonic sensors should not be within 6 ft of an air vent).

## Open office examples

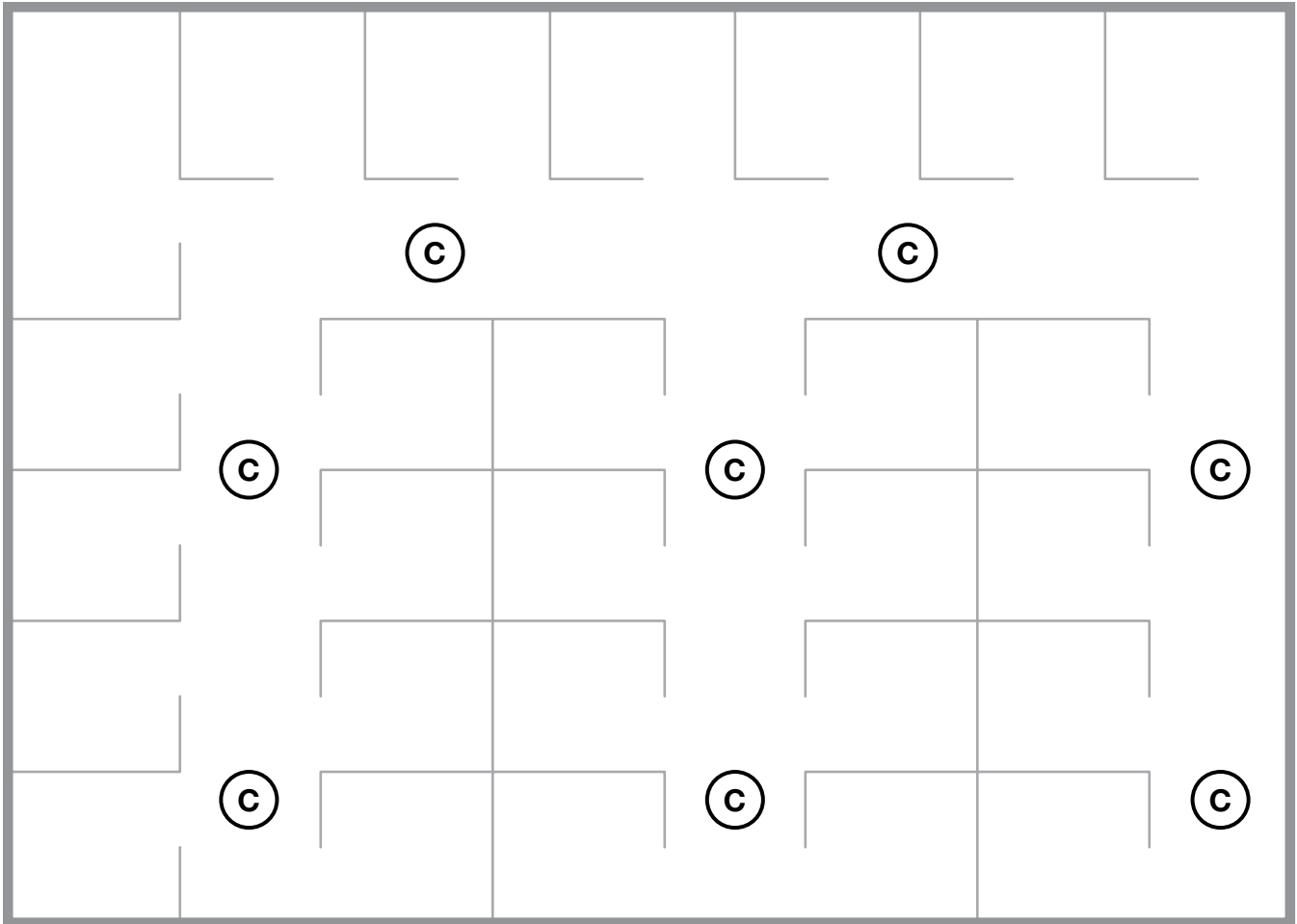

### Example 1

In this example, we placed ceiling-mounted sensors along the walkway so the coverage pattern overlaps to avoid dead spots. We also placed the sensors away from air vents in order to avoid reliability issues.

 = Ceiling sensor

# Sensor placement—private offices

Coverage area and ceiling height is usually not an issue in a private office, so you'll have more options for sensor placement. Furniture layout, though, is an issue. An in-wall occupancy sensor may be an option as long as the view from the light switch to the rest of the room is unimpeded. In most cases, though, a wall-mount or ceiling-mount occupancy sensor is your best choice.

## Helpful hints

- The desk should be within the minor motion coverage area of a sensor (turning a page in a book is an example of minor motion).
- The door should be in clear view of a sensor.
- If you're using in-wall or wall-mounted sensors, make sure that tall furniture such as a bookcase will not obstruct the view of the room.
- Make sure that any in-wall or wall-mounted sensor's view of the room isn't blocked by the door when it's open.
- Make sure that the sensor's view of the entrance won't be blocked by the door when it's open (you might need to use another sensor to help cover the entrance).
- Don't mount sensors close to air vents, as the vibration and air flow can reduce the effectiveness of the sensor (PIR sensors should not be within 4 ft of an air vent, and ultrasonic sensors should not be within 6 ft of an air vent).
- Avoid having the sensor looking out the door of the space. If you're using a ceiling mounted sensor, mount it close to the wall with the door on it. If you're using a wall-mounted sensor, mount the sensor on the wall with the door.

## Private office examples

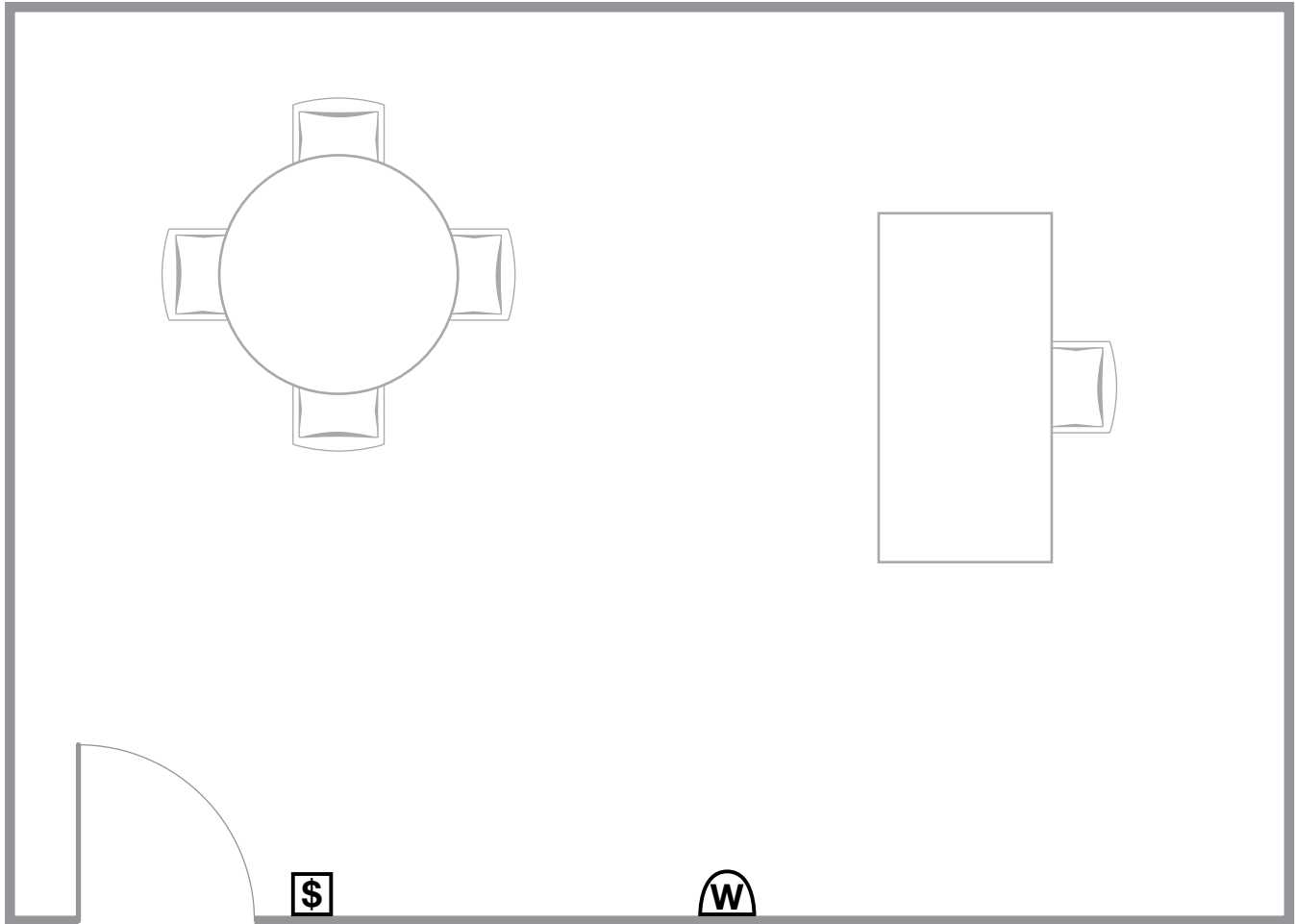

### Example 1

In this example, a wall-mounted sensor makes the most sense. The desk is close enough to the wall to be within the minor motion coverage area, and using a wall-mounted sensor along the same wall as the door prevents the sensor from looking out into the space. Because the door opens into the space, the sensor can see someone entering regardless of the door's position. In terms of the sensor's lateral position along the wall, we want to keep it close to the desk, but away from any air vents that might be in the ceiling.

 = Wall control

 = Wall sensor

## Private office examples

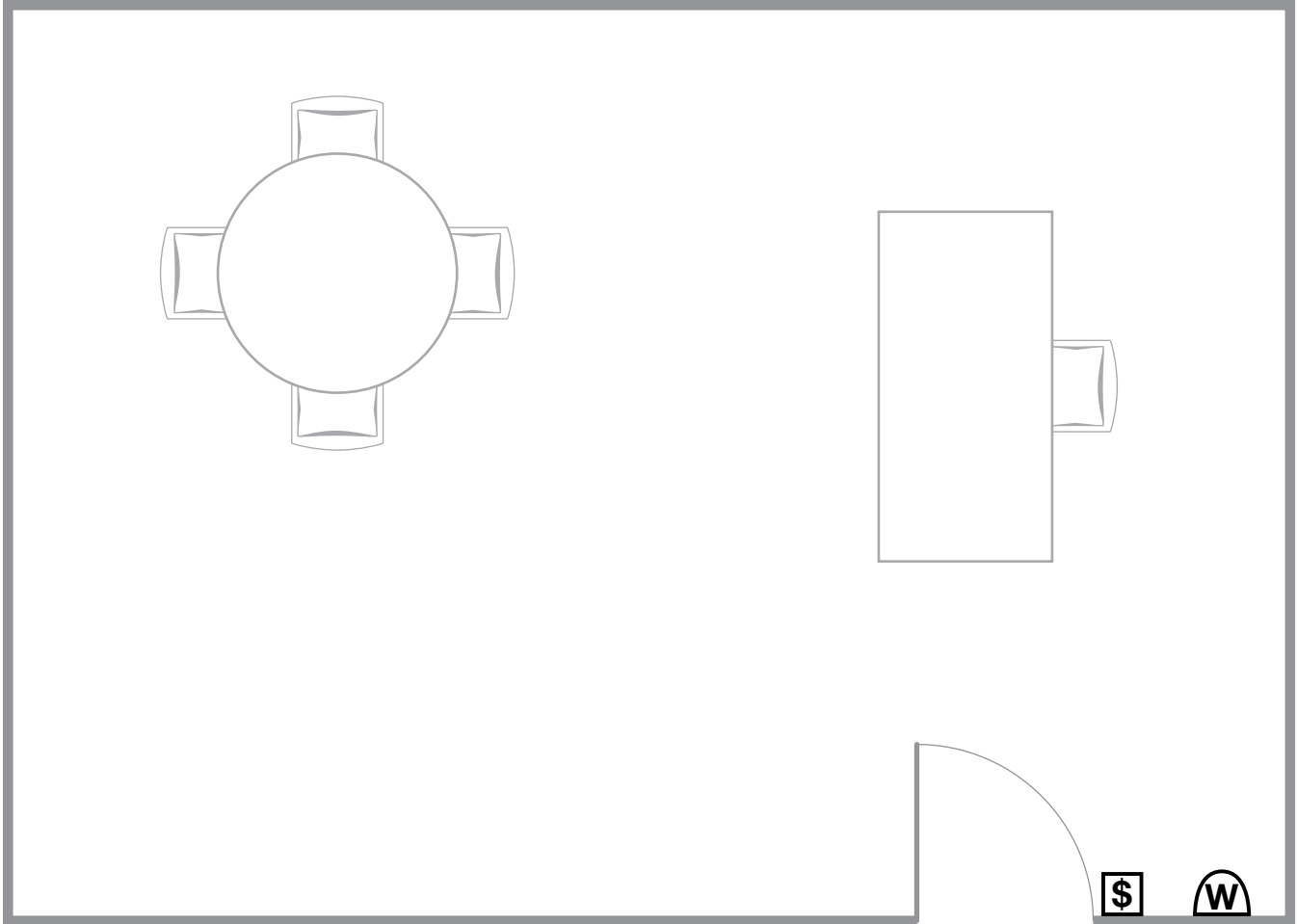

### Example 2

When comparing this example to the previous one, you can see that the way the door opens can pose an issue. If we placed a wall sensor where we did in the previous example, the sensor's view of the entrance would be blocked by the door when the door was open. By moving the sensor to the right side of the door, the sensor still has a clear view of the desk and the room, as well as now having a view of the entrance. The view of the room right along the wall with the door is lost when the door is open, but in this case that's acceptable since there isn't any focus area along that wall. If there was a focus area located along that wall we'd need to use an additional sensor.

 = Wall control

 = Wall sensor



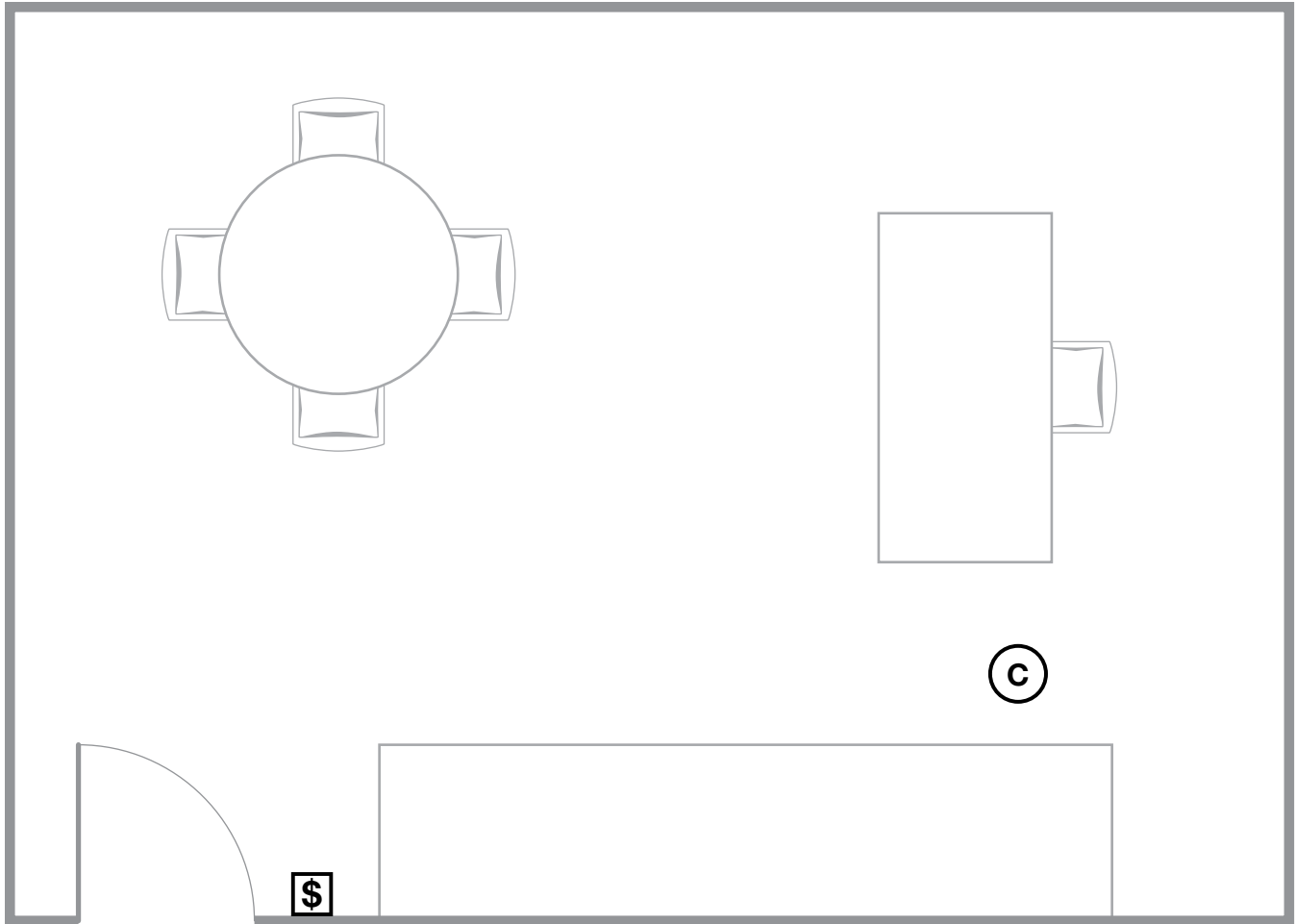

### Example 3

In this example we're using a ceiling-mounted occupancy sensor. This type of sensor is ideal for spaces that have tall furniture along a wall.

When placing the sensor on the ceiling, we want to try to have the desk inside of the minor motion coverage area, but we also want to keep the sensor as close to the wall with the door as possible in order to minimize the sensor's view out the door. Any air vents in the space will also affect sensor placement.

**\$** = Wall control

**C** = Ceiling sensor

# Sensor placement—restrooms

Restrooms are an ideal application for an occupancy sensor, since the space is only occupied periodically throughout the day. When selecting an occupancy sensor for use in a larger public restroom, it's important to understand exactly what area of the room needs to be covered.

## **Helpful hints**

- Cover all entrances and open areas by a sensor(s). Stall coverage is based on customer preference.
- If stalls won't be covered by a sensor, program a longer timeout (15 or 30 minutes) to help prevent the lights from turning off when someone is in the stall.
- You might need to use multiple sensors if the restroom is an odd shape or has a separate entrance room.
- An in-wall sensor works well for individual restrooms.
- Avoid mounting sensors close to air vents, as the vibration and air flow can reduce the effectiveness of the sensor (PIR sensors should not be within 4 ft of an air vent, and ultrasonic sensors should not be within 6 ft of an air vent).

## Restroom examples

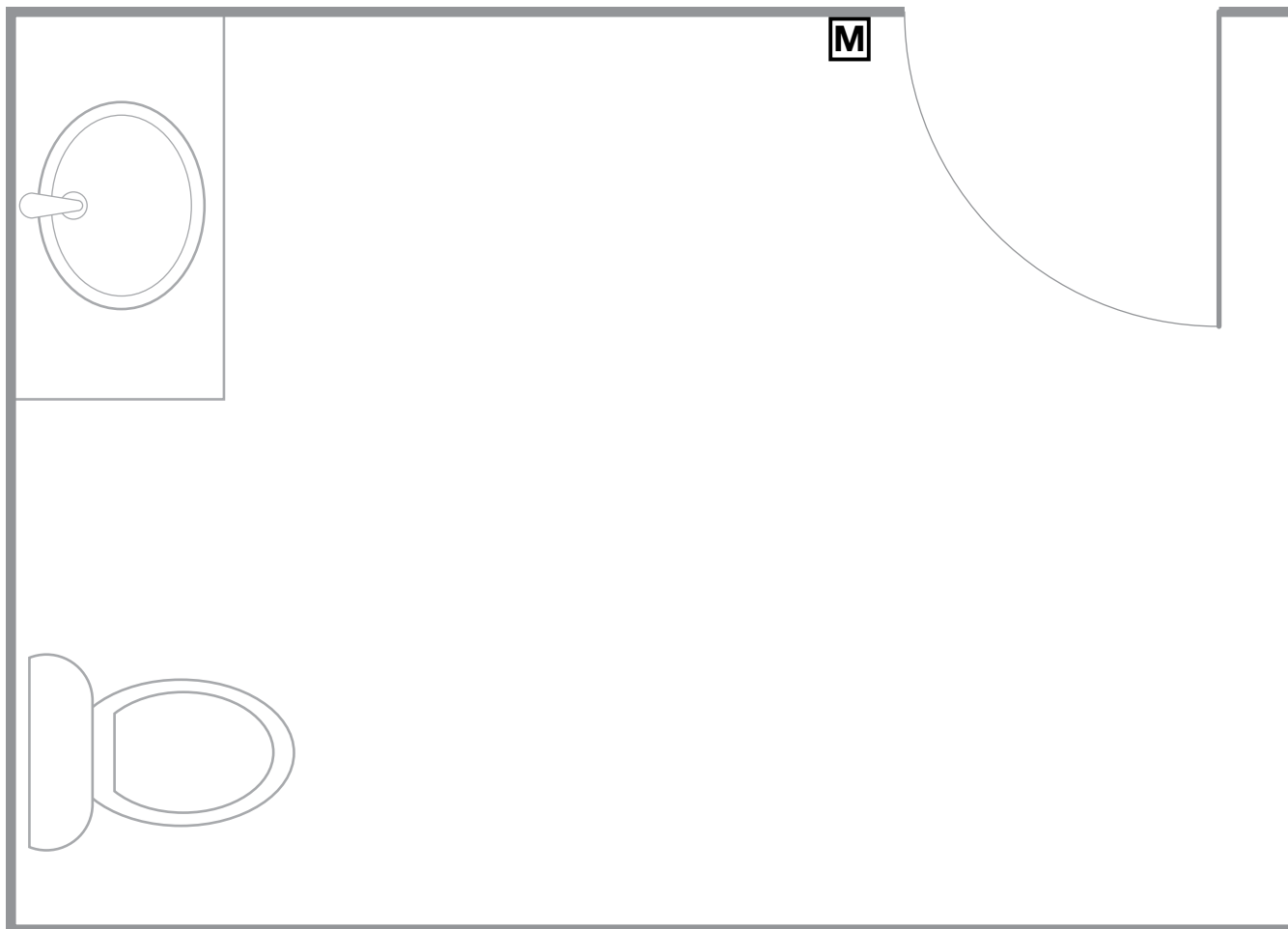

### Example 1

In a private restroom, in-wall sensors make an excellent standalone solution. The position of the switch in this room gives view to the whole room as well as the entrance. (An in-wall sensor isn't ideal if the switch is located in a recessed entrance or doesn't have a view of the entire space.)

**M** = Maestro® in-wall sensor

## Restroom examples

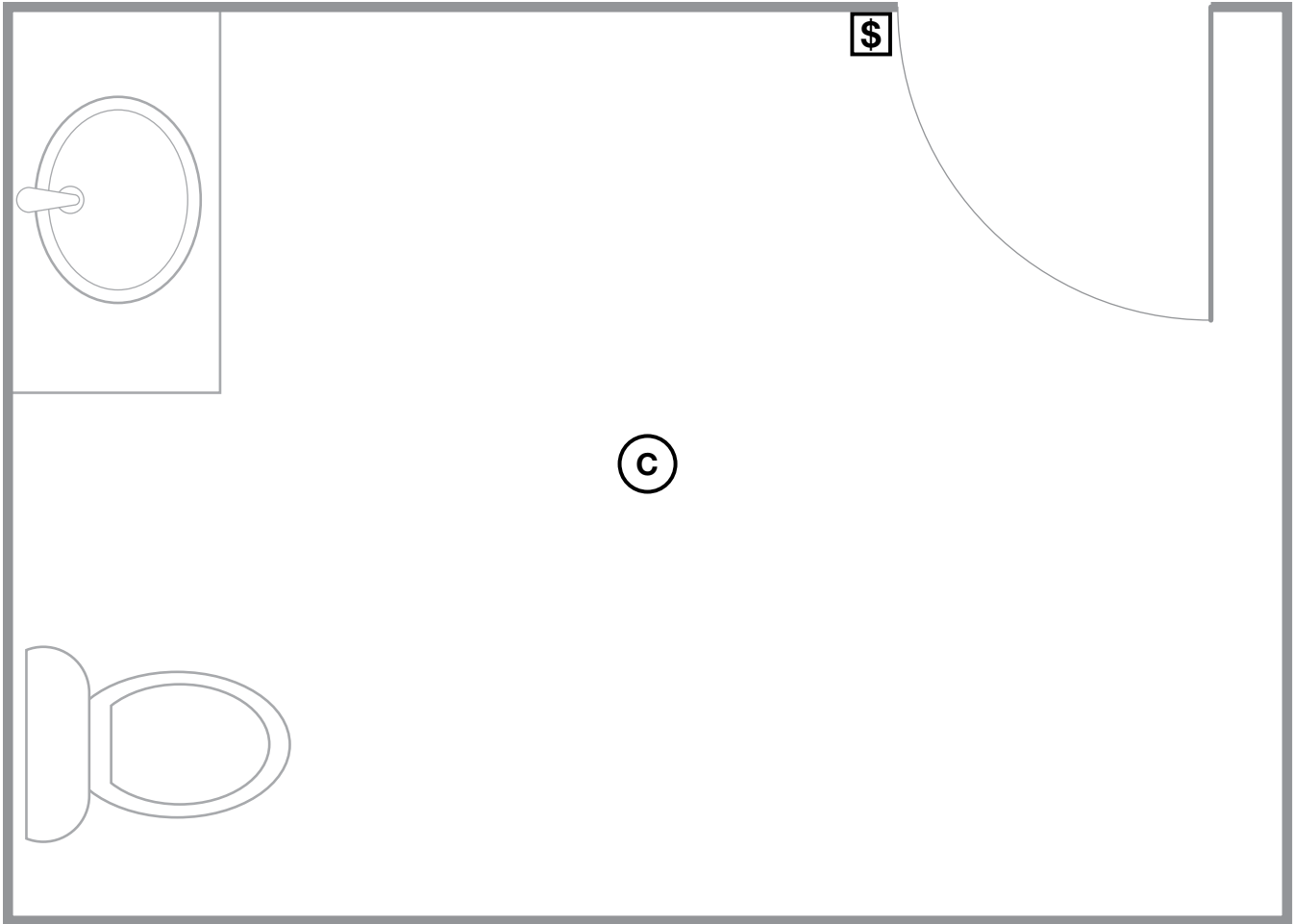

### Example 2

In this example, we'll assume that an in-wall sensor is unacceptable due to system capability or viewing issues. The ceiling-mount sensor has more than enough coverage area for the space, but we'll need to avoid air vents and fans in the ceiling. We'll also need to keep the sensor as close to the wall with the door as possible, in order to minimize the amount of space that the sensor looks out on. If the door is spring-loaded so that it's always closed, then this isn't an issue.

**C** = Ceiling sensor

**\$** = Wall control

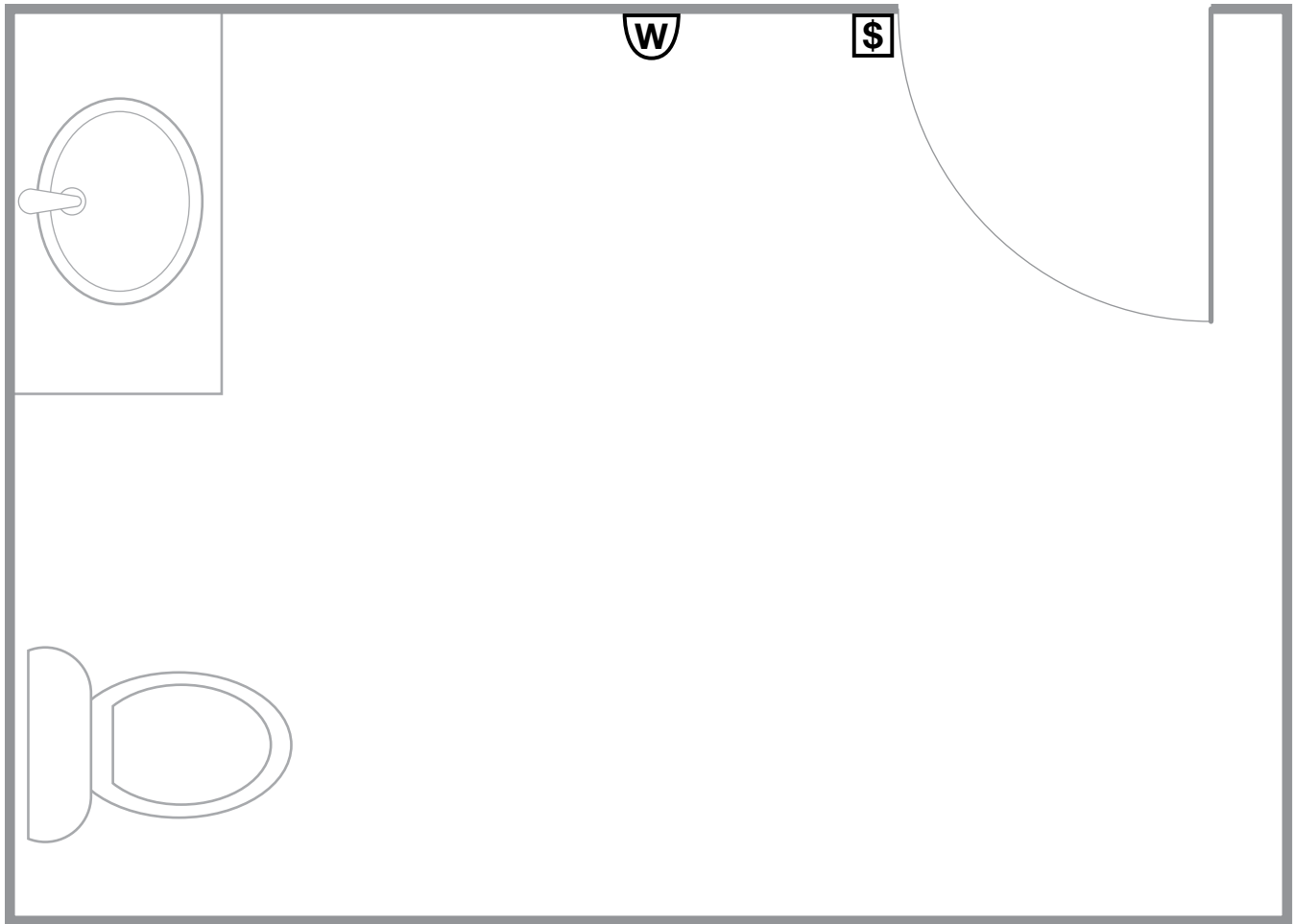

### Example 3

If the door wasn't spring-loaded, and subsequently might be left open when the space is unoccupied, using the wall-mounted sensor would be a better solution. A wall-mounted sensor placed along the wall with the door provides complete coverage of the space while making sure that the sensor doesn't see out of the space.

 = Wall sensor

 = Wall control



## Restroom examples

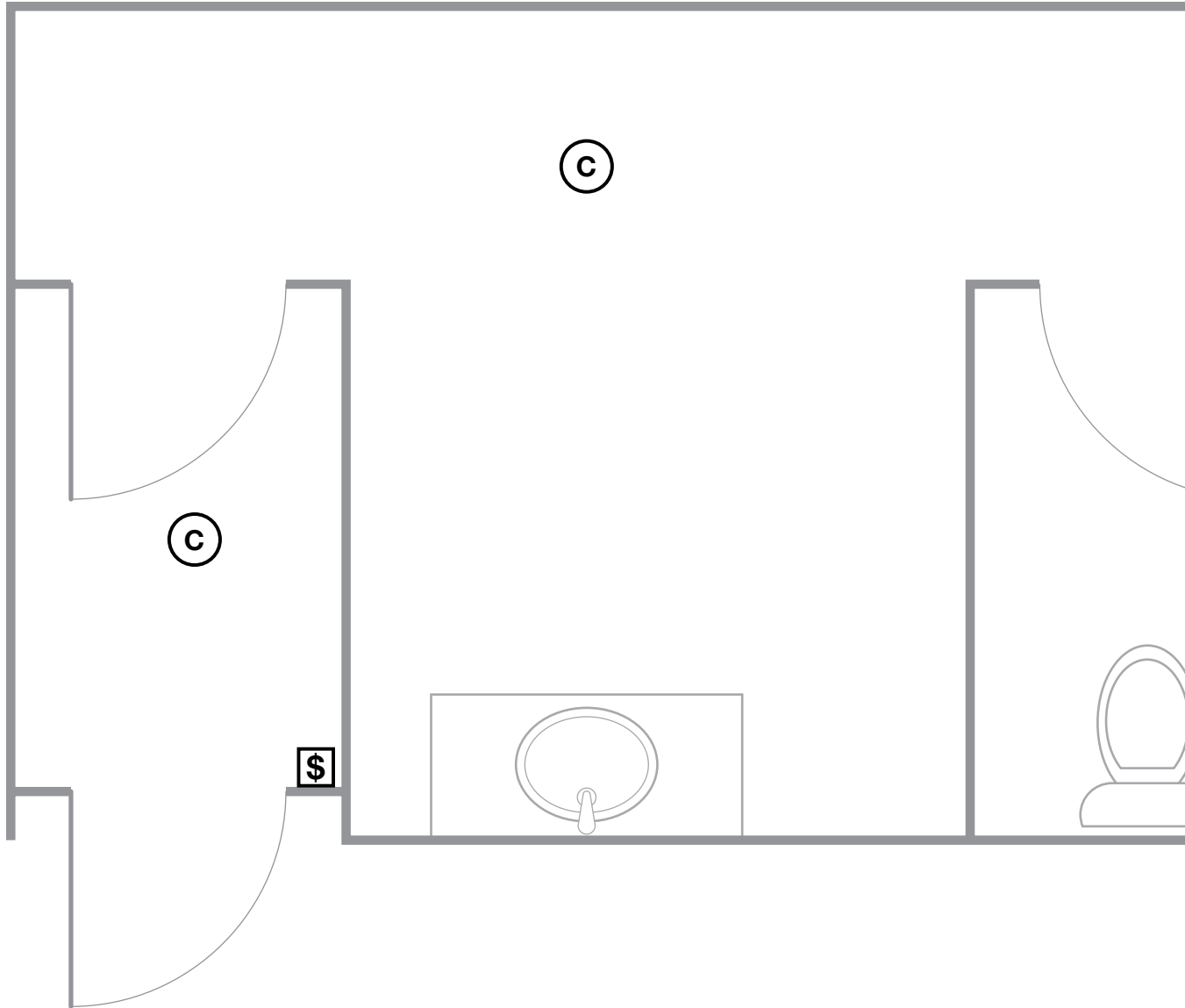

### Example 4

In this example, we'll assume the customer wanted complete coverage of the space, including the stalls. We have one sensor for the privacy room, one for the main restroom, and one for the stalls (you could substitute a wall-mounted sensor for the ceiling-mounted sensor that is covering the main space). Again, when placing these sensors we need to keep in mind air vents or fans in the space.

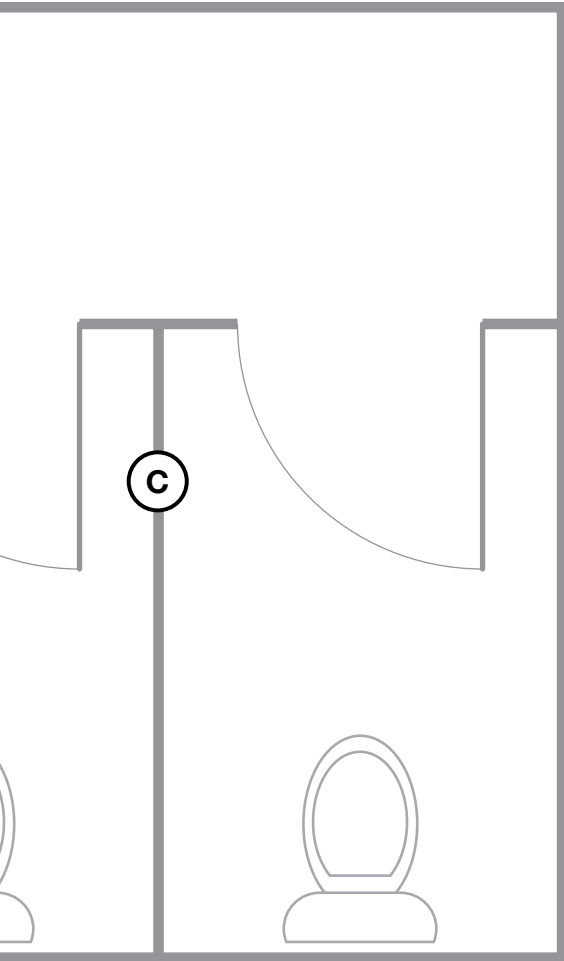

**\$** = Wall control

**C** = Ceiling sensor

## Restroom examples

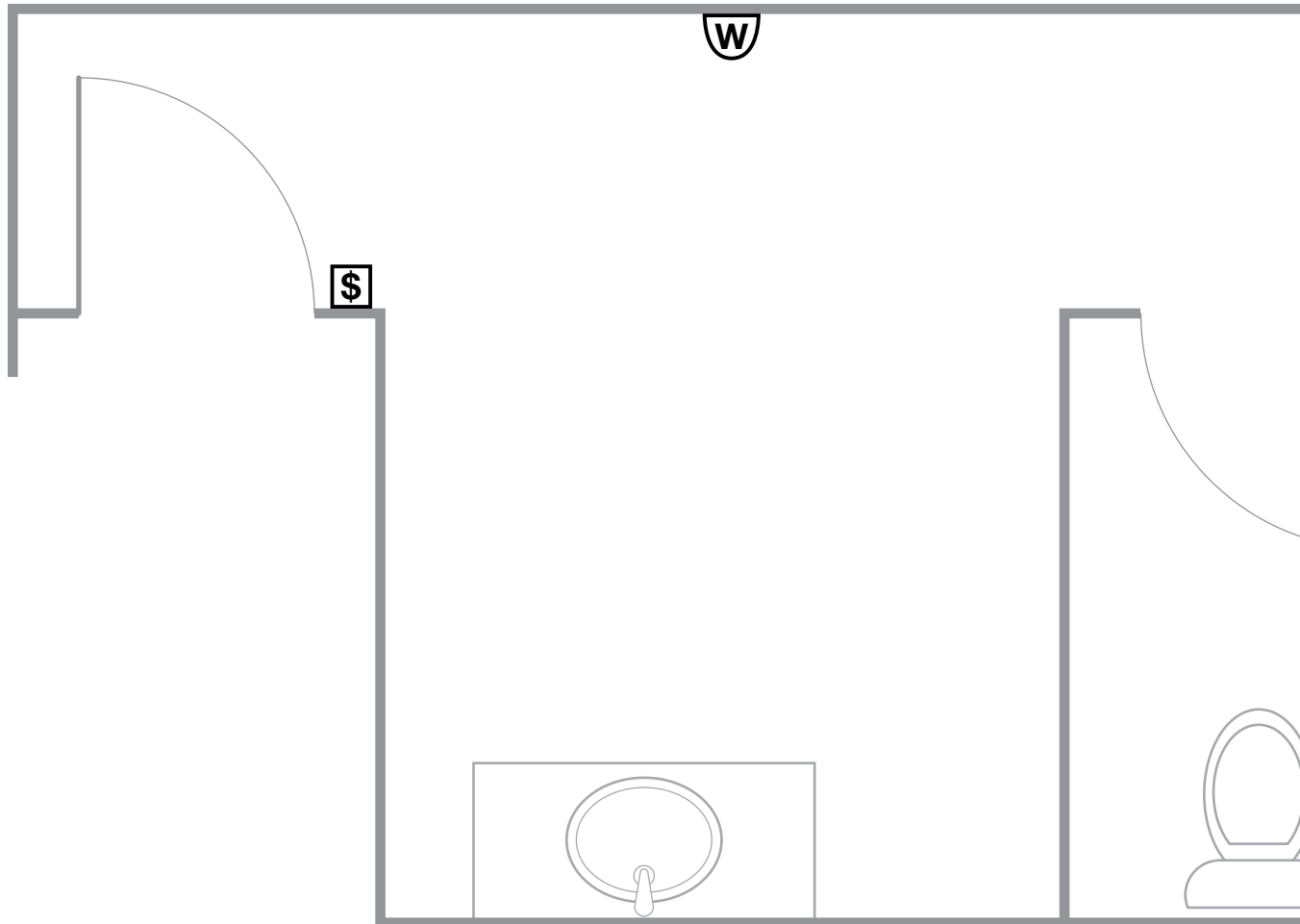

### Example 5

This example is similar to Example 4, only the customer doesn't want the stalls to be covered. The wall-mounted sensor provides complete coverage of the main space in the restroom. A ceiling-mounted sensor could be used in place of the wall-mounted one.



**\$** = Wall control

**C** = Ceiling sensor

# Sensor placement—hallways

When designing the occupancy solution for a hallway, you'll need to take the shape and length of the hallway and the position of entrances and doorways into account. You need to cover all areas where people might enter the hallway or have reason to linger. Although you can use ceiling-mounted sensors, the larger coverage patterns of the wall-mounted and hallway sensors tend to prove more cost effective for long hallways.

## Helpful hints

- Make sure all possible access points to the hallway are covered by the sensor(s).
- Program a longer timeout to avoid lights constantly turning on/off, which is distracting to people in the rooms lining the hallway.
- Don't mount sensors close to air vents, as the vibration and air flow can reduce the effectiveness of the sensor (PIR sensors should not be within 4 ft of an air vent, and ultrasonic sensors should not be within 6 ft of an air vent).
- When using wireless sensors in long hallways, be aware of RF range limitations back to wireless landing points.
- When using the hallway sensor, be aware that hallway width has an effect on detection length.
- You can use an armature mounting bracket to help mount hallway sensors to the ceiling.

## Hallway examples

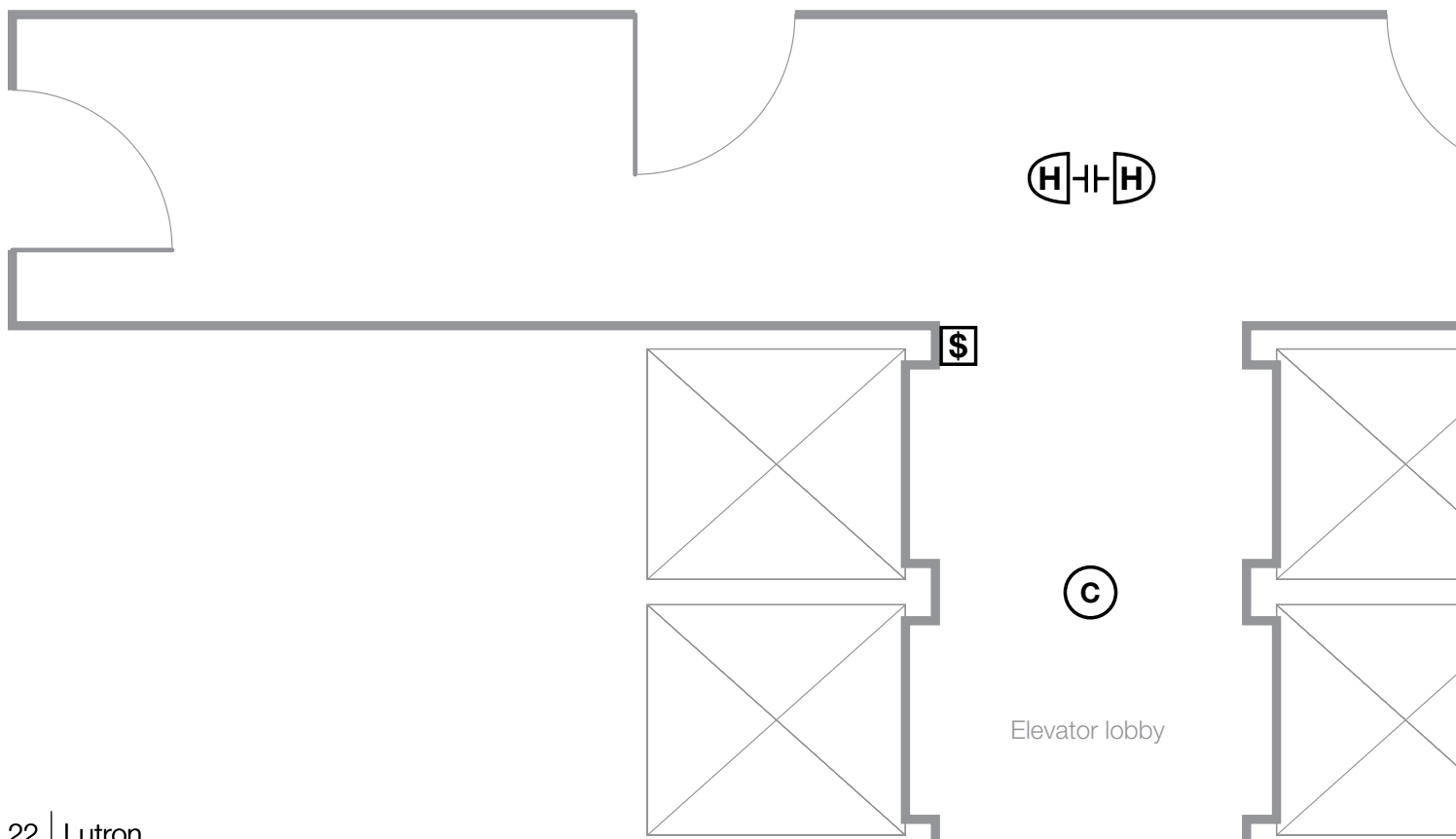



### Example 1

In this example, we're using the hallway sensors with the armature in order to mount the sensors in the center of the hallway, so we can cover the hallway. We're assuming that the hallway is long enough to require two sensors in order to completely cover its length. Notice that the sensor placement covers all entrances to the hallway. We placed the sensors in the middle of the hallway (with regards to width) as the coverage pattern is based on the width of the hallway. Air vents in the ceiling can change where you put the sensors along the length of the hallway, which is acceptable as long as the sensors are not lined right at a door, which would block the sensors from seeing the entrance.

Note that we're using a ceiling-mounted sensor to cover the elevator lobby in order to pick up anybody entering the space from the elevators. Please note that it's ok to have some uncovered space directly below the two hallway sensors as long as there isn't an entrance to the space or an area where people might stand long enough for the sensor to time out.



 = Wall control

 = Ceiling sensor

 = Armature mounted to ceiling

 = Hallway sensor

# Sensor placement—hallways

## Hallway examples

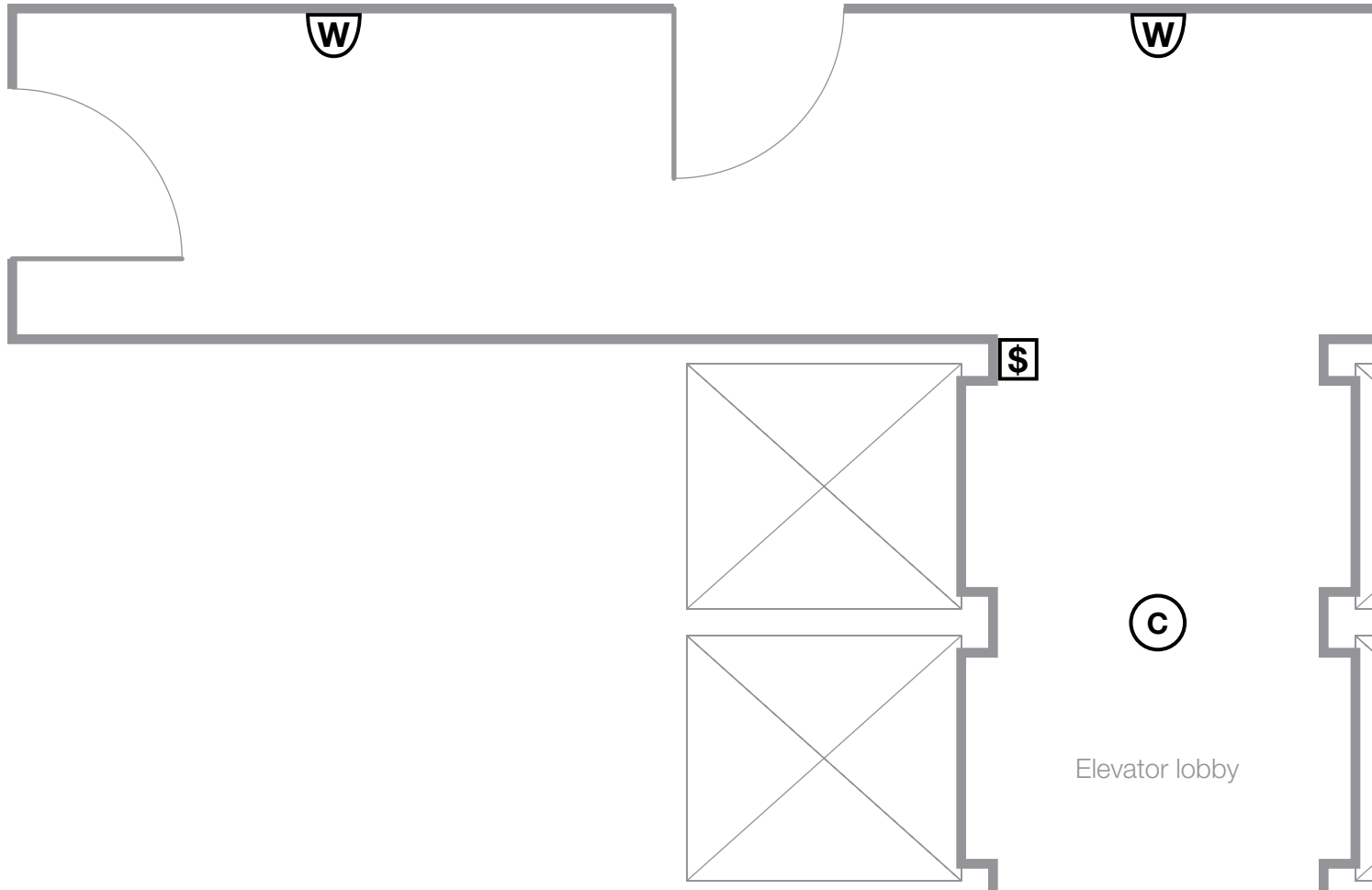

### Example 2

In this example we're using wall-mounted sensors in order to cover the length of the hallway. You can use wall-mounted sensors in shorter hallways where the hallway sensor might be unnecessary, in narrow hallways where the hallway sensor's range is affected by the width, or in any other application where the hallway sensor isn't ideal. Here, wall-mounted sensors cover all entrances to the space. The sensors don't need to look into the rooms along the hallway, as generally it's ok to have the hallway lights on if the rooms along the hallway are occupied. Again, we're using a ceiling-mounted occupancy sensor in the elevator lobby to pick up anyone entering the space from that entrance.

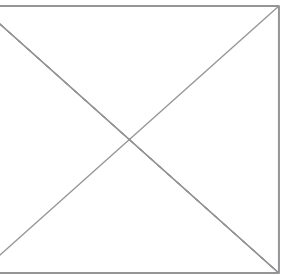
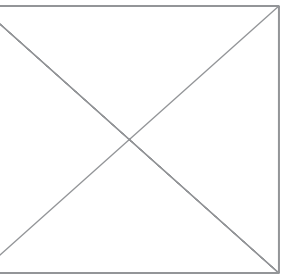

**W** = Wall sensor

**C** = Ceiling sensor

**\$** = Wall control

# Sensor placement—classrooms

When designing a sensor solution for a classroom, it's important to keep in mind the focus points of the room, such as the teacher's desk or a sitting area at the back of the room. It's also important to have the sensor covering the entrance to the room without looking out the door into the adjacent space. You should always try to keep these focus areas inside the sensor's minor-motion coverage.

## Helpful hints

- Generally, avoid ceiling-mounted occupancy sensors in classrooms because of the tendency of things to be hung from the ceiling, which might obstruct the sensor's views.
- The sensors should cover the teacher's desk, the entrance, and any other areas where people might sit for long periods of time.
- Covering all of the desks might not be necessary. Covering the teacher's desk and major areas of the room will often be enough to ensure that the sensor won't time out when it shouldn't.
- Try to avoid having the sensor looking out the door of the space. Keep ceiling-mounted sensors close to the wall with the door on it. If you're using a wall-mounted sensor try to mount the sensor on the wall with the door.
- Make sure that the sensor's view of the entrance won't be blocked by the door when it's open. Resolving this issue will sometimes require using another sensor to help cover the entrance.
- Don't mount sensors close to air vents, as the vibration and air flow can reduce the effectiveness of the sensor (PIR sensors should not be within 4 ft of an air vent, and ultrasonic sensors should not be within 6 ft of an air vent).

## Classroom examples

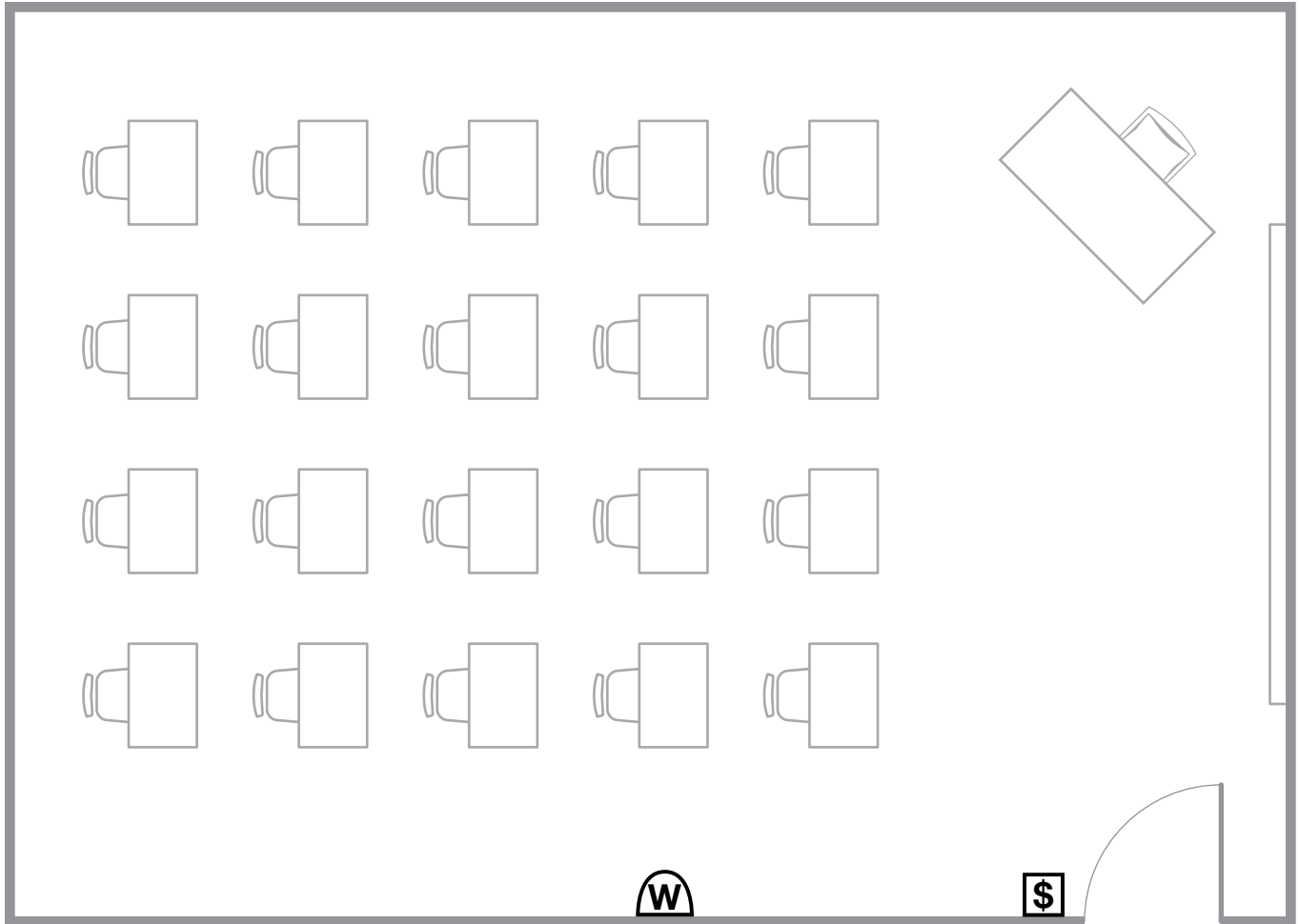

### Example 1

In this example we're focusing on the teacher's desk, the front of the room, and the entrance. By placing a wall-mounted sensor along the wall with the door and putting it toward the front of the room, we keep the focus areas in our minor-motion coverage area while ensuring that the sensor doesn't look out of the space. A wall-mounted sensor avoids looking out of the space; we could also move the sensor laterally to avoid any obstructions. While a corner-mounted sensor might cover the space, we could only place it in four locations, which limits the ability for adjustments based on the variables of the space. Covering the back of the classroom isn't a priority, as the front of the room will be occupied when the back of the room is also occupied.

 = Wall sensor

 = Wall control

# Sensor placement—classrooms

## Classroom examples

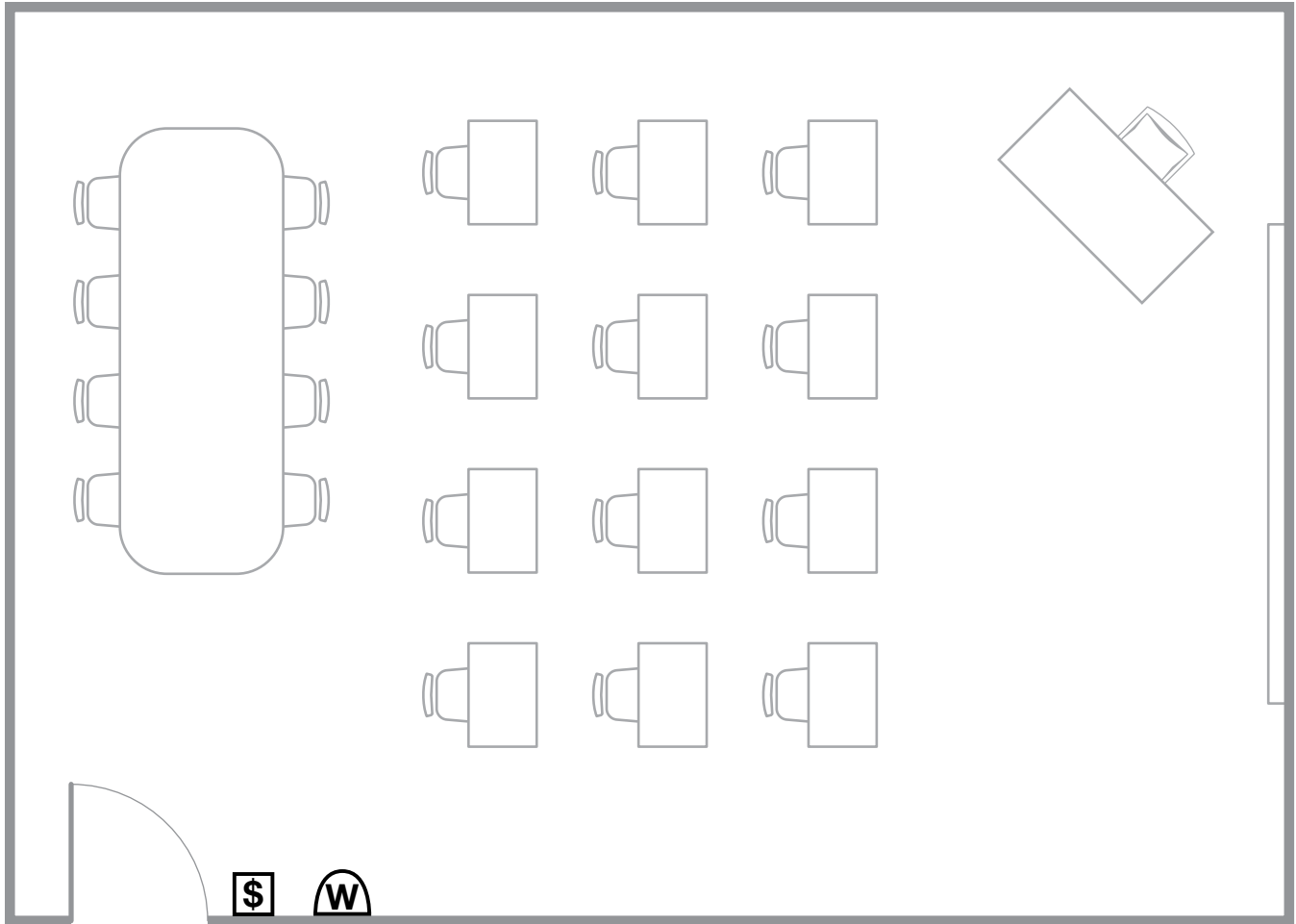

### Example 2

This example is similar to the previous one. The primary difference here is the addition of another focus area at the back of the room. Notice that the door is in a different position, but how the door opens into the space doesn't change the sensor placement. However, we need to make sure we have coverage in the group activity area in the back of the room. So we'll slide the wall mounted sensor down the wall toward the back of the room until both the front of the room and the back of the room are covered. If the room is large enough, we may need to place an additional wall-mounted sensor on the same wall, toward the front of the room. Using the sensor(s) in this manner allows us to cover the front of the room including the teacher's desk, the back group activity area, and the entrance.

= Wall control

= Wall sensor

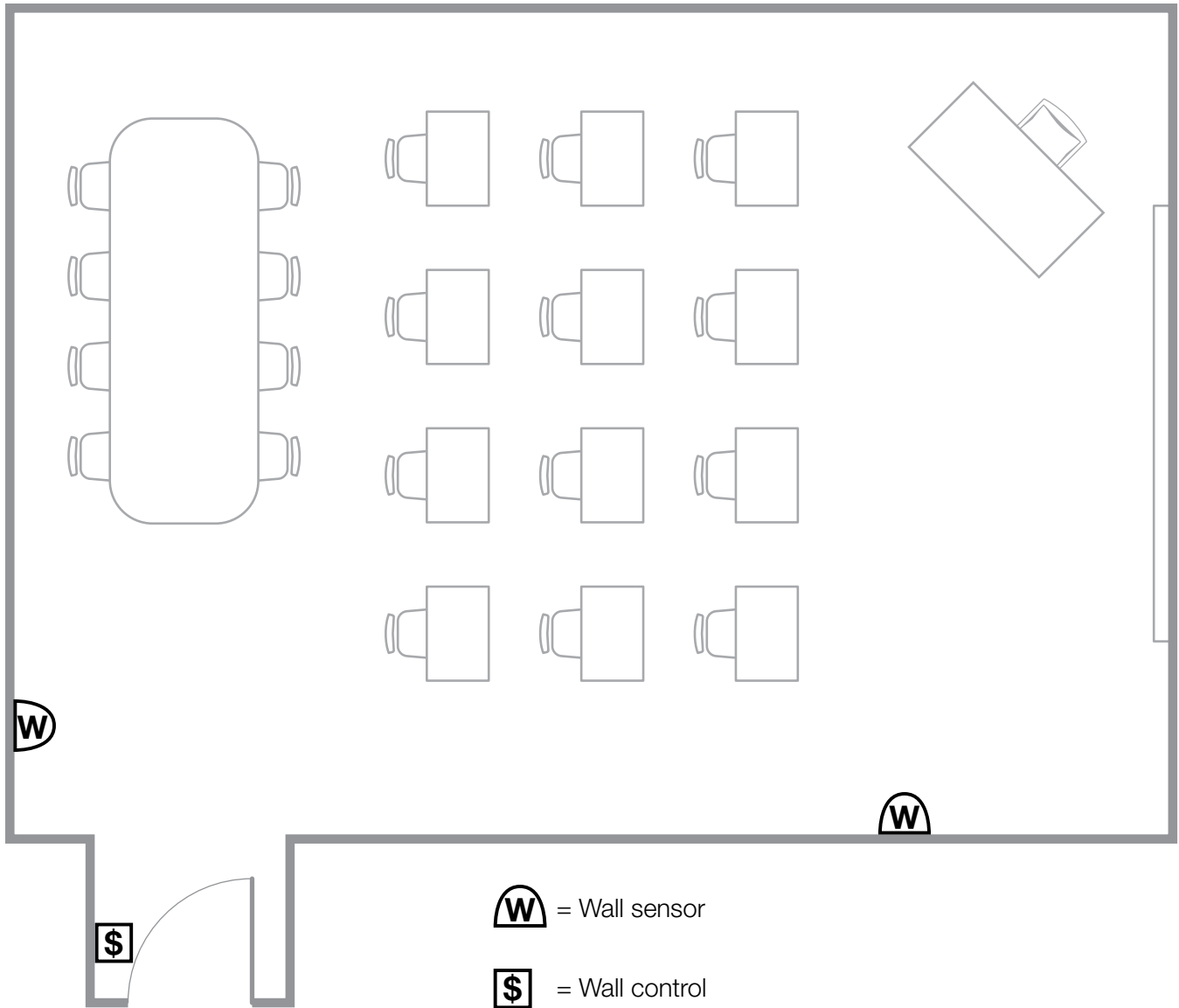

### Example 3

This example is very similar to Example 2, except with a recessed entrance, which is common in classrooms due to lockers and other hallway features. In this case, we still want to cover the front of the room with minor motion coverage to account for the teacher sitting at the desk. We accomplish this by using the wall-mounted sensor toward the front of the classroom. Covering the entrance to the room is slightly more difficult, as it's important to have coverage at the entrance without looking outside of the space. We placed a wall-mounted sensor along the back wall of the classroom, so that the sensor can see the door to pick up people walking into the space. The corner of the wall will block the sensor from seeing out the door when it's open.

This type of setting often involves some trial and error to get the right placement.



# Sensor placement—conference rooms

In a conference room, the entrances, conference table, and possibly the presentation area all need to be covered by the occupancy sensor. It's also important to make sure that the sensor's view is not blocked by anything in the room, such as pendant fixtures, doors, furniture, or projection screens.

## **Helpful hints**

- Try to avoid having the sensor looking out the door of the space. Keep ceiling-mounted sensors close to the wall with the door on it. If you're using a wall-mounted sensor try to mount the sensor on the wall with the door.
- Make sure that the sensor's view of the entrance won't be blocked by the door when it's open. You might need to install another sensor to help cover the entrance.
- Don't mount sensors close to air vents, as the vibration and air flow can reduce the effectiveness of the sensor (PIR sensors should not be within 4 ft of an air vent, and ultrasonic sensors should not be within 6 ft of an air vent).

## Conference room examples

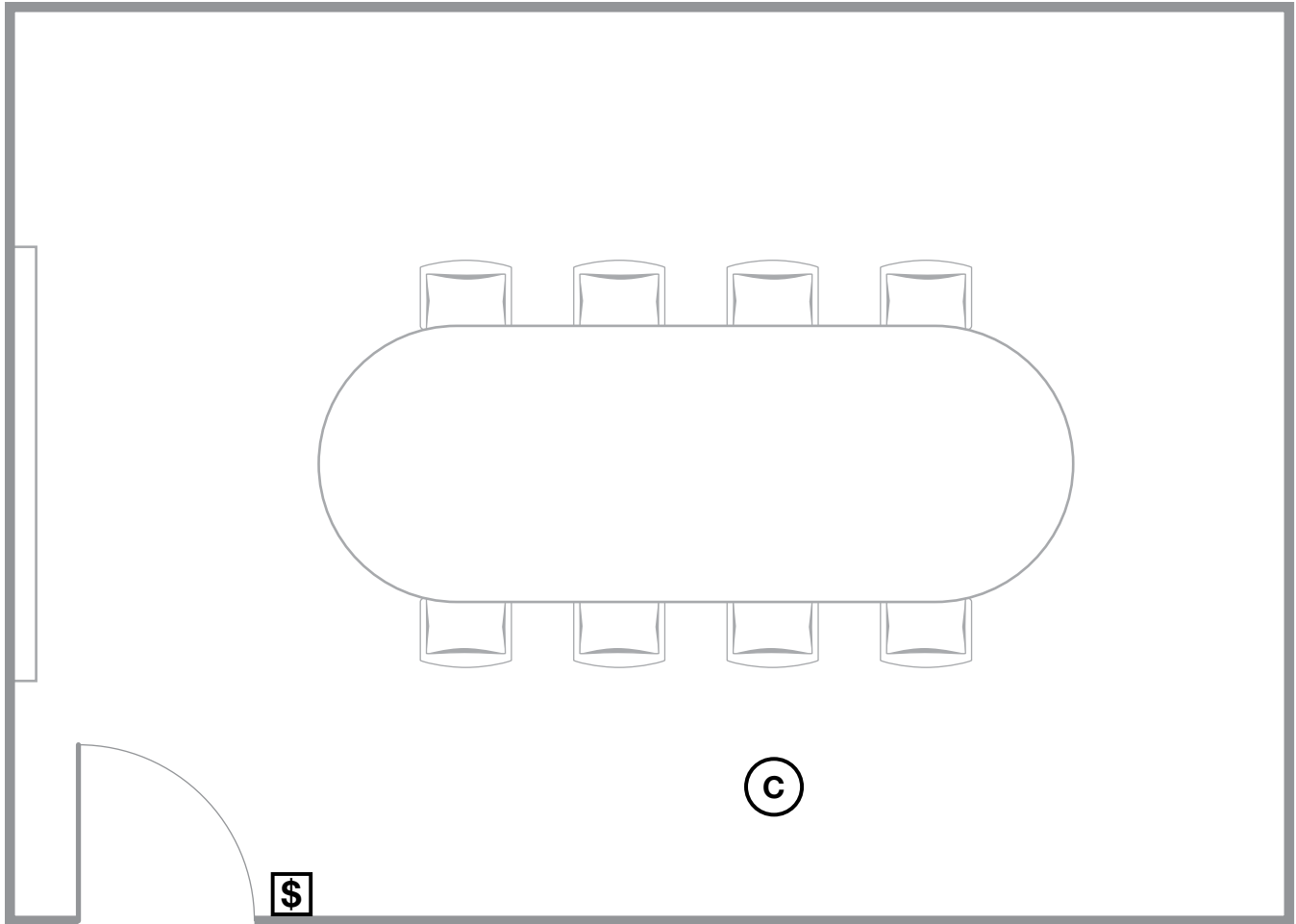

### Example 1

This standard conference room doesn't have any hanging fixtures or projectors that might block a sensor's view from the ceiling, so a ceiling-mounted sensor is best for this space. We placed the sensor close to the wall with the door in order to minimize the sensor's view into the adjacent space. This sensor will cover the entrance and the table, as well as the presentation area at the front of the room.

**\$** = Wall control

**C** = Ceiling sensor

## Conference room examples

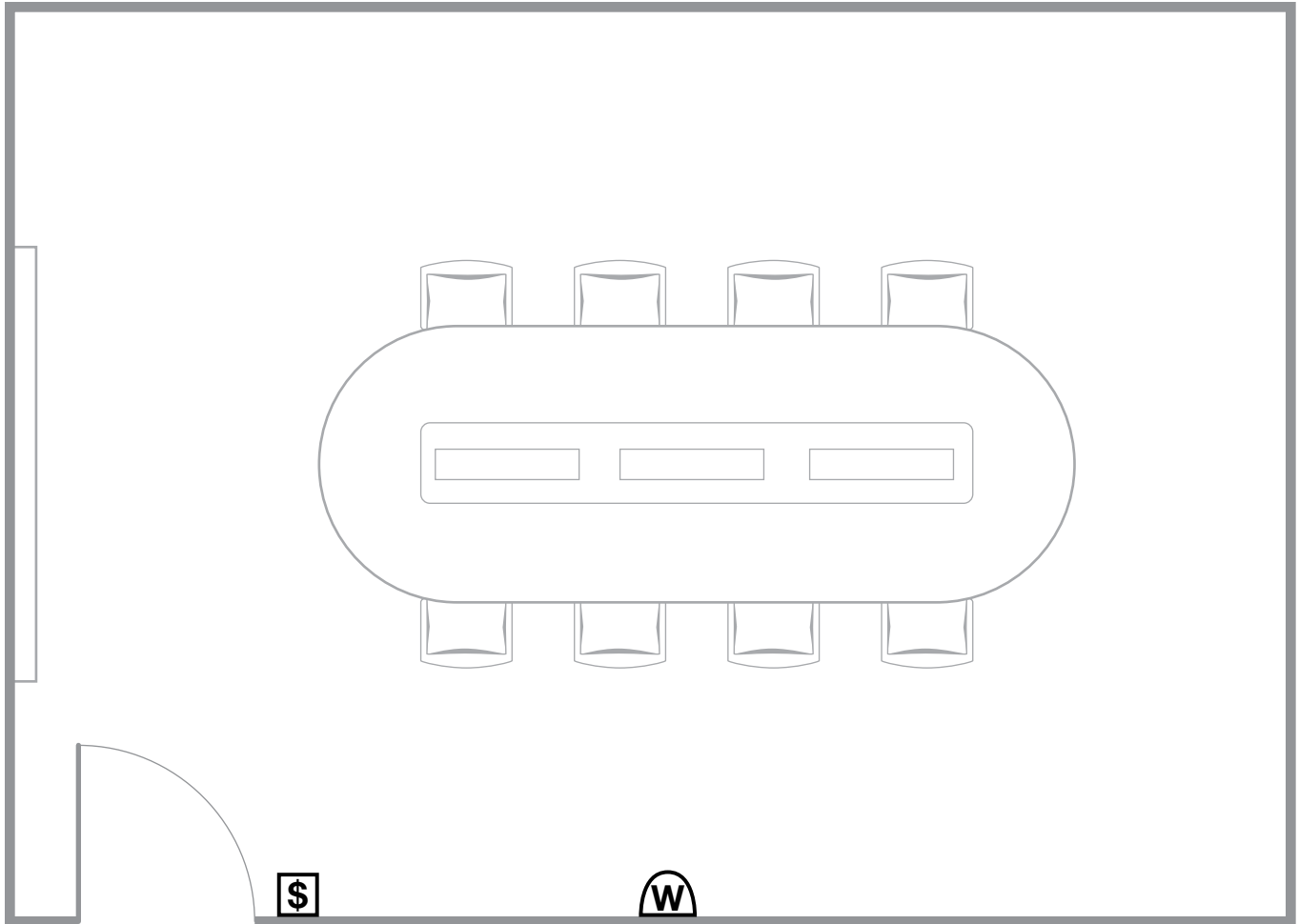

### Example 2

This example has a hanging device such as a pendant fixture or ceiling mounted projector, which makes the use of a ceiling-mounted sensor unacceptable. The wall-mounted sensor provides complete coverage without looking out the door into the adjacent space.

 = Wall control

 = Wall sensor

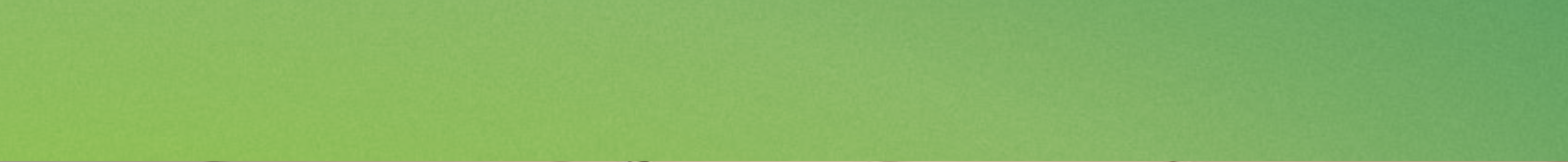

# Sensor placement—warehouses

Warehouse applications can be very difficult, but a properly designed occupancy sensor solution can help ensure that only areas that are being used are illuminated. The challenges in a warehouse are usually based around the high ceiling as well as the possibility of false tripping in individual aisles as people walk near the entrance. Finding the proper layout involves paying close attention to the coverage patterns of the sensors and adjusting them to cover exactly to the edge of an occupancy space.

## Helpful hints

- You can use armature mounts to gain more flexibility for sensors, which helps ensure they won't look into other areas.
- Ceiling-mounted sensors are not applicable because of the high ceilings.
- You can mount hallway, corner, and wall-mount sensors horizontally to fit their field of view to the space. See App note 432—Warehouse Aisle Wireless Sensors— for details.
- When looking down an aisle that has a walkway on both ends, adjusting the sensor's view by tilting the sensor up/down can change the distance the sensor is able to see.
- Mounting sensors on an armature mounted at the end of an aisle is not always a feasible solution, as some customers have concerns about knocking the sensors off with forklifts and other equipment.
- Don't mount sensors close to air vents, as the vibration and air flow can affect the effectiveness of the sensor (PIR sensors should not be within 4 ft of an air vent, and ultrasonic sensors should not be within 6 ft of an air vent).

## Warehouse examples

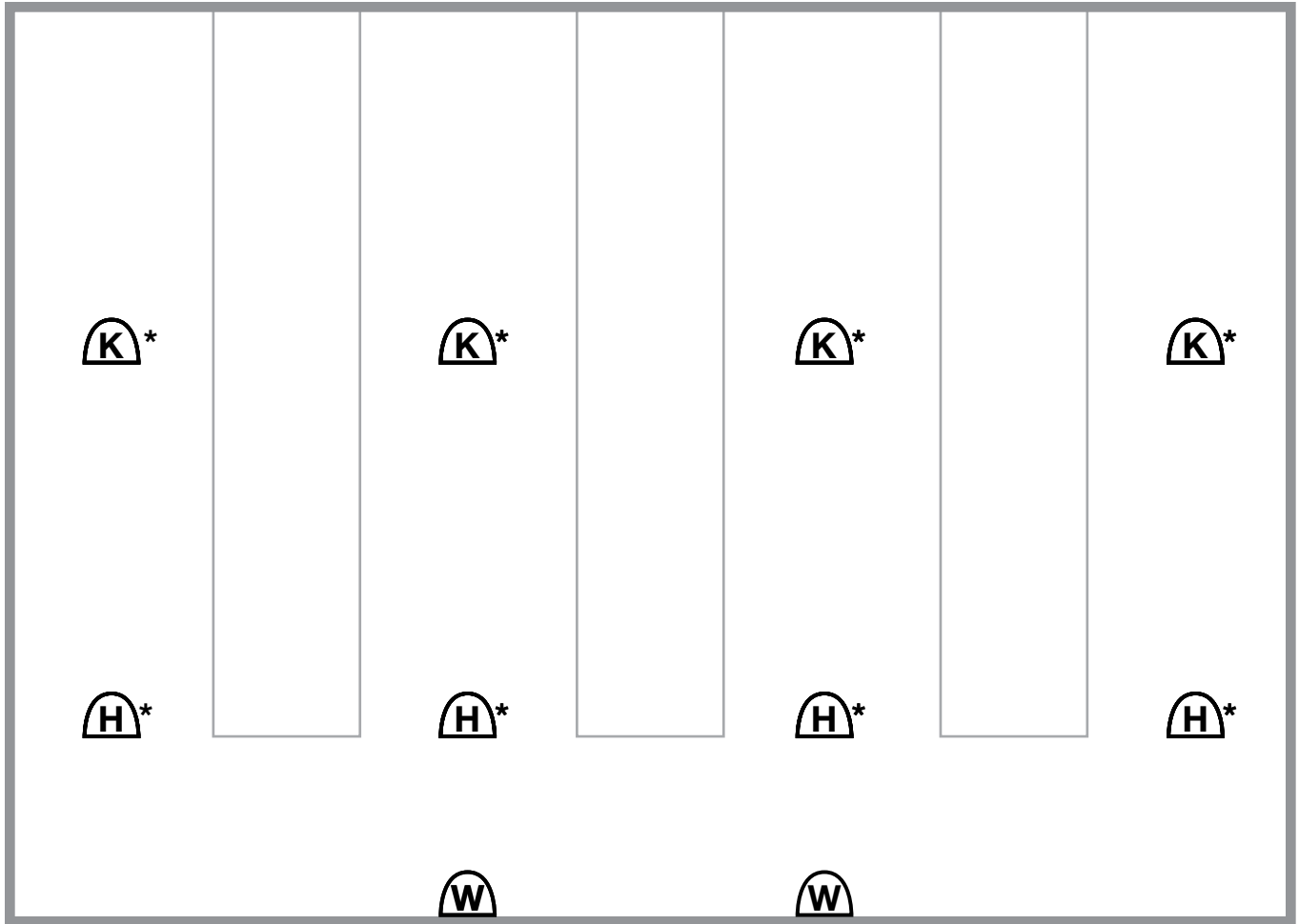

### Example 1

This example uses hallway-mounted sensors, wall-mounted sensors, and corner-mounted sensors mounted horizontally instead of vertically in order to change their coverage patterns. We can get around the high ceiling issue in the main walkway by mounting a wall-mounted sensor horizontally so that the coverage pattern runs the length of the walkway. We can also cover the walkway by mounting a hallway sensor on a wall (as in Example 2 on page 36).

 = Corner sensor

 = Hallway sensor

 = Wall sensor

\* For detailed instructions on how to do the aisle sensor layout, please see app note 432.

## Warehouse examples

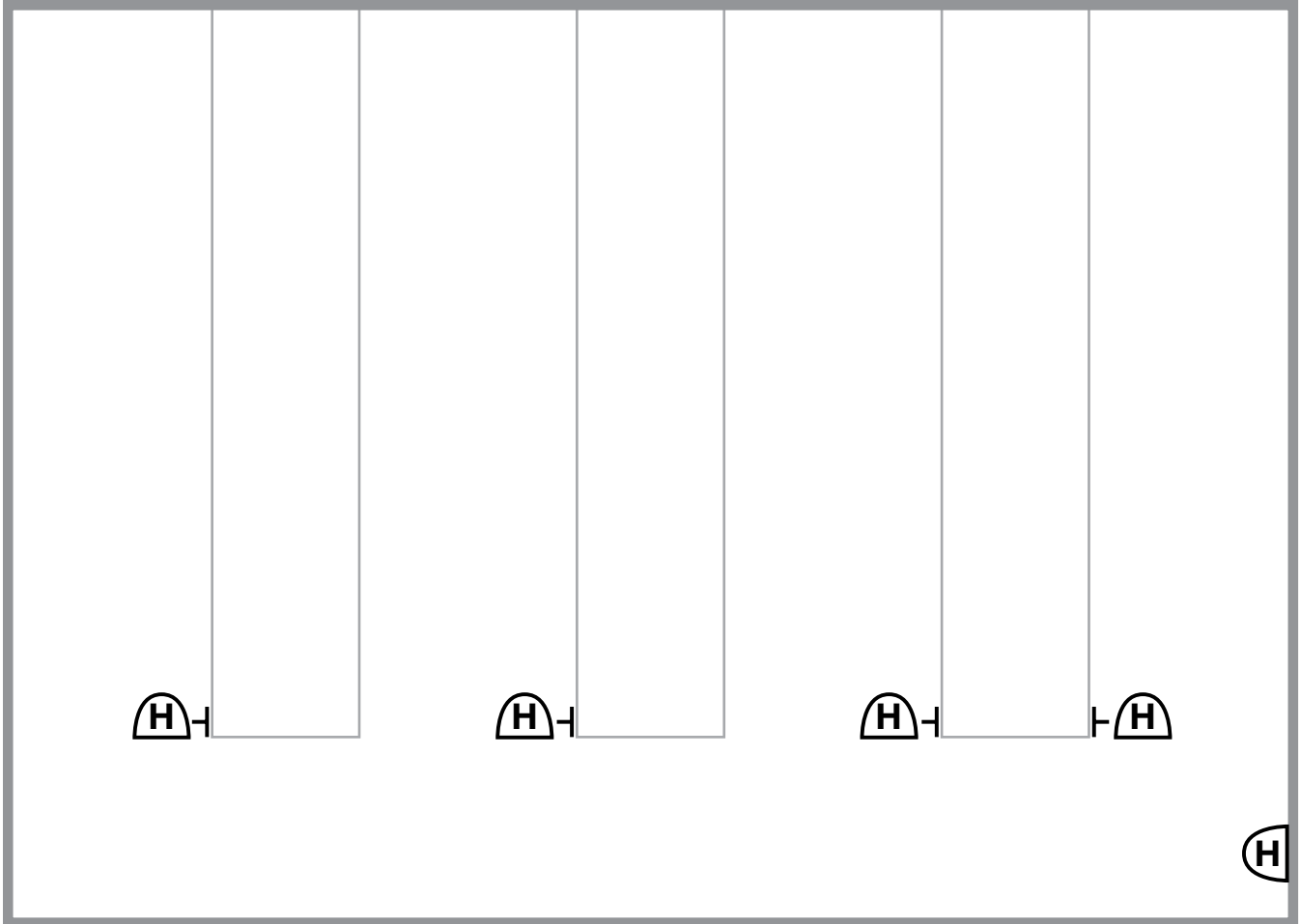

### Example 2

In this example we'll assume that there were issues with placing sensors on the ceiling. In order to cover the aisles, we'll use hallway sensors mounted on armatures and pointed down the aisles. We'll need to adjust the elevation angle of the armature to ensure that the sensor coverage doesn't look into an aisle at the far end. If the sensor is looking into the aisle at the far end, tilt the sensor downward to shorten its field of view. The main walkway is covered by a hallway sensor mounted on a wall and pointing the length of the walkway.

 = Hallway sensor

 = Armature



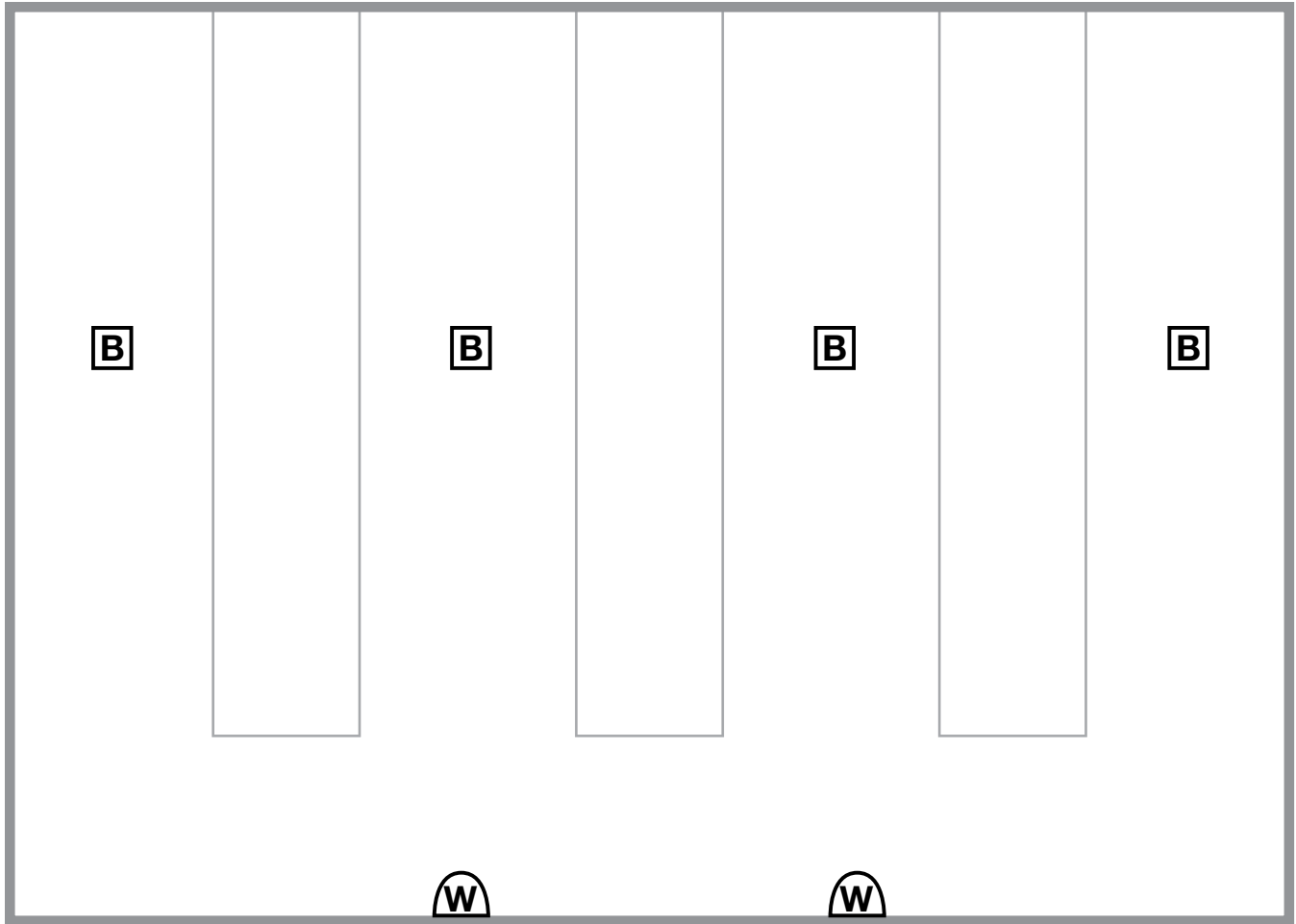

### Example 3

In this example, we used our high-bay occupancy sensors for the aisles. These sensors are made specifically for use in high ceiling applications. When using these, we want to place them in locations the aisle to avoid looking out into the adjacent hallway. Wall sensors cover the main walkway.

 = Wall sensor

 = High bay sensor



# Sensor placement—lecture halls

The large size of a lecture hall, varying ceiling height, hanging projectors and screens, and multiple entrances can make occupancy sensor layout in this space challenging. Ceiling-mounted sensors usually can't be used in the portions of the room with high ceilings, but we want to be sure to cover the presentation area, as it's generally the main focus of the space. It's important that the sensor see as much of the seating area as possible, which is difficult due to the ceiling height. In addition, every entrance needs to be covered to ensure that the lights will always come on when someone enters the space.

## Helpful hints

- Ceiling-mounted sensors may work in the upper part of the room where the ceiling is lower.
- Don't place sensors in a location that might be covered by a projection screen.
- You don't need to cover every square inch of space with occupancy sensors, but you do need to cover all the focus areas.
- Try to avoid having the sensor looking out the door of the space. Keep ceiling-mounted sensors close to the wall with the door on it. If you're using a wall mounted sensor, try to mount the sensor on the wall with the door.
- Make sure that the sensor's view of the entrance won't be blocked by the door when it's open. You might need to use another sensor to help cover the entrance.
- Don't mount sensors close to air vents, as the vibration and air flow can reduce the effectiveness of the sensor (PIR sensors should not be within 4 ft of an air vent, and ultrasonic sensors should not be within 6 ft of an air vent).

## Example 1

In this example, the high ceiling in the front of the lecture hall is addressed by using a wall-mounted sensor along the front wall. This sensor will cover the presentation area/stage in the front to ensure that the lights stay on when someone is presenting. This sensor should also cover the entrances on that level. If the sensor doesn't cover those entrances, you might need additional sensors. Wall-mounted sensors placed along the side walls provide coverage over the sitting area and the steps, while two ceiling-mounted sensors handle the entrances and walkway at the top of the steps. You could also use a wall-mounted sensor along the back wall if ceiling mounted sensors aren't ideal.

 = Wall control

 = Wall sensor

 = Ceiling sensor

# Lecture hall example

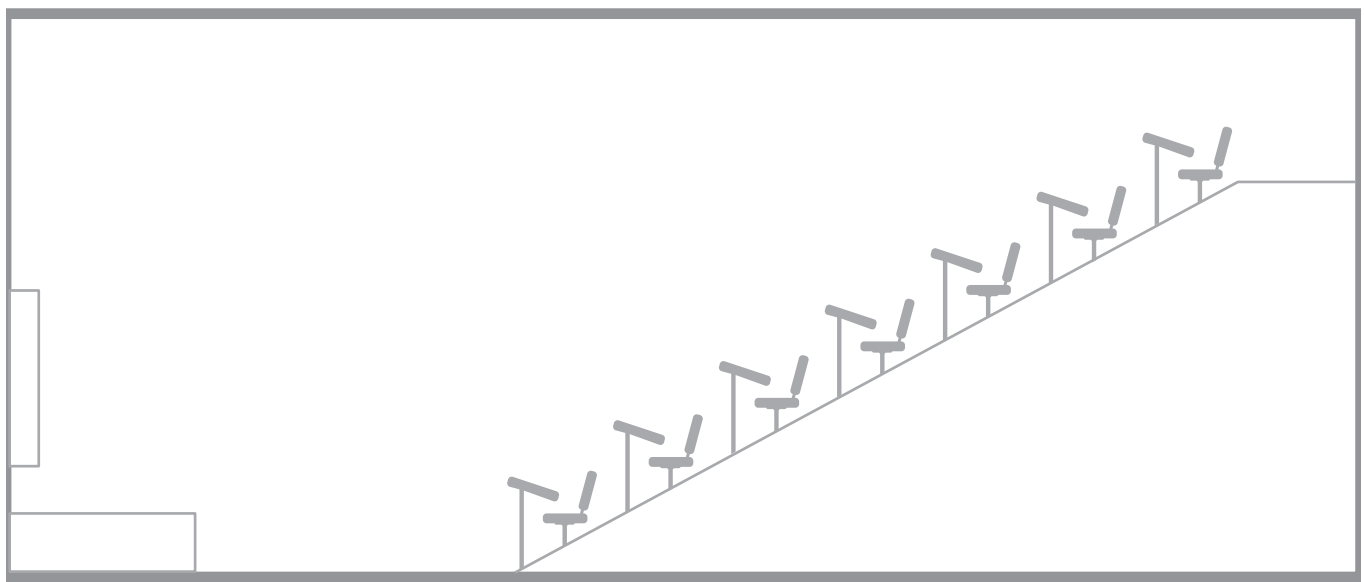
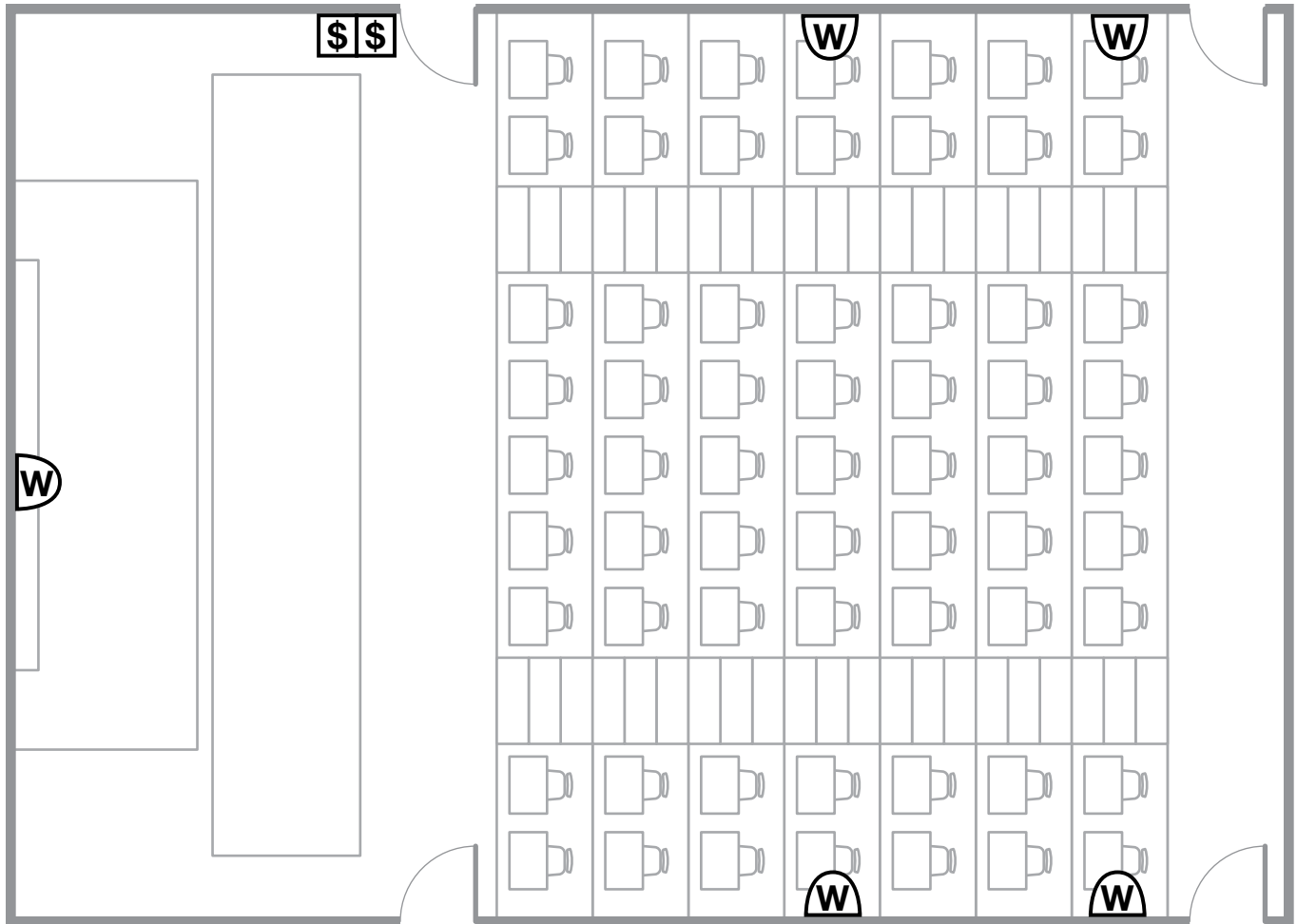

# Sensor placement—gymnasiums

Ceiling-mounted occupancy sensors aren't an option in gymnasiums because of the high ceilings. Other issues in gymnasiums include the potential for damage to sensors and the presence of other equipment mounted on walls and hanging from ceilings, which can obstruct a sensor's view. Equipment mounted on walls (such as basketball hoops and bleachers) also limits sensor placement.

## **Helpful hints**

- Be sure to account for all possible entrances with sensor coverage.
- If damage to the sensors is a concern, use wire guards to protect them.
- If you need to mount sensors higher than usual because of wall-mounted equipment, use an armature to mount the sensor. This way, you can tilt the sensor downward to compensate for the higher height.
- You don't need to cover every square inch of the space by occupancy sensors as long as all of the focus areas are covered.
- Try to avoid having the sensor looking out the door of the space. Keep ceiling-mounted sensors close to the wall with the door on it and wall-mounted sensors on the wall with the door.
- Don't mount sensors close to air vents, as the vibration and air flow can reduce the effectiveness of the sensor (PIR sensors should not be within 4 ft of an air vent, and ultrasonic sensors should not be within 6 ft of an air vent).

## Gymnasium examples

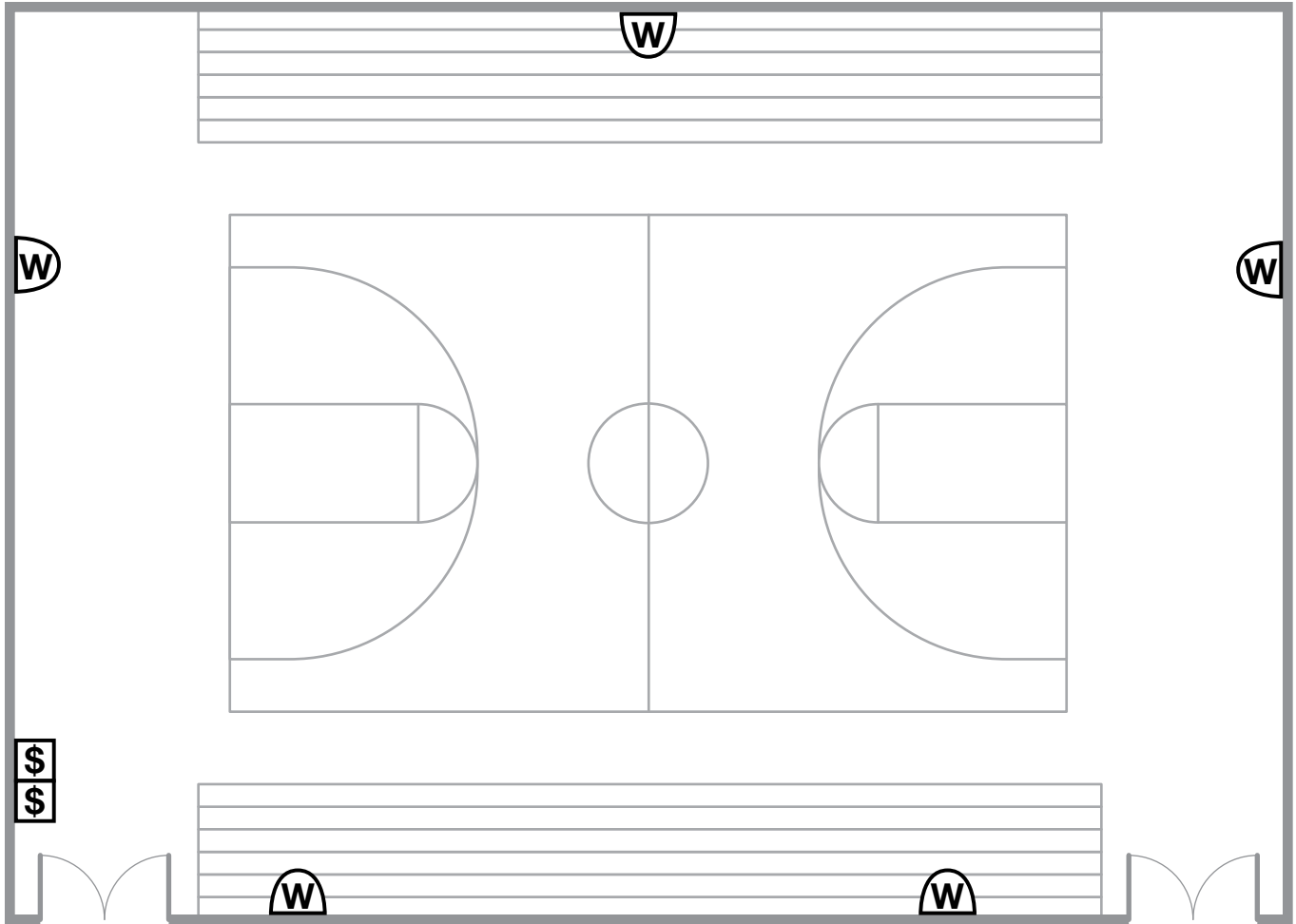

### Example 1

In this example, the high ceiling and hanging equipment eliminate using ceiling-mounted sensors, so we've used wall-mounted sensors instead. We placed them around the perimeter to ensure coverage of the area as well as to make sure the entrances are covered. In order to avoid the hanging basketball hoops, we've placed the sensors off-center on the two end walls, so they're not directly behind the hoops.

 = Wall sensor

 = Wall control



## Gymnasium examples

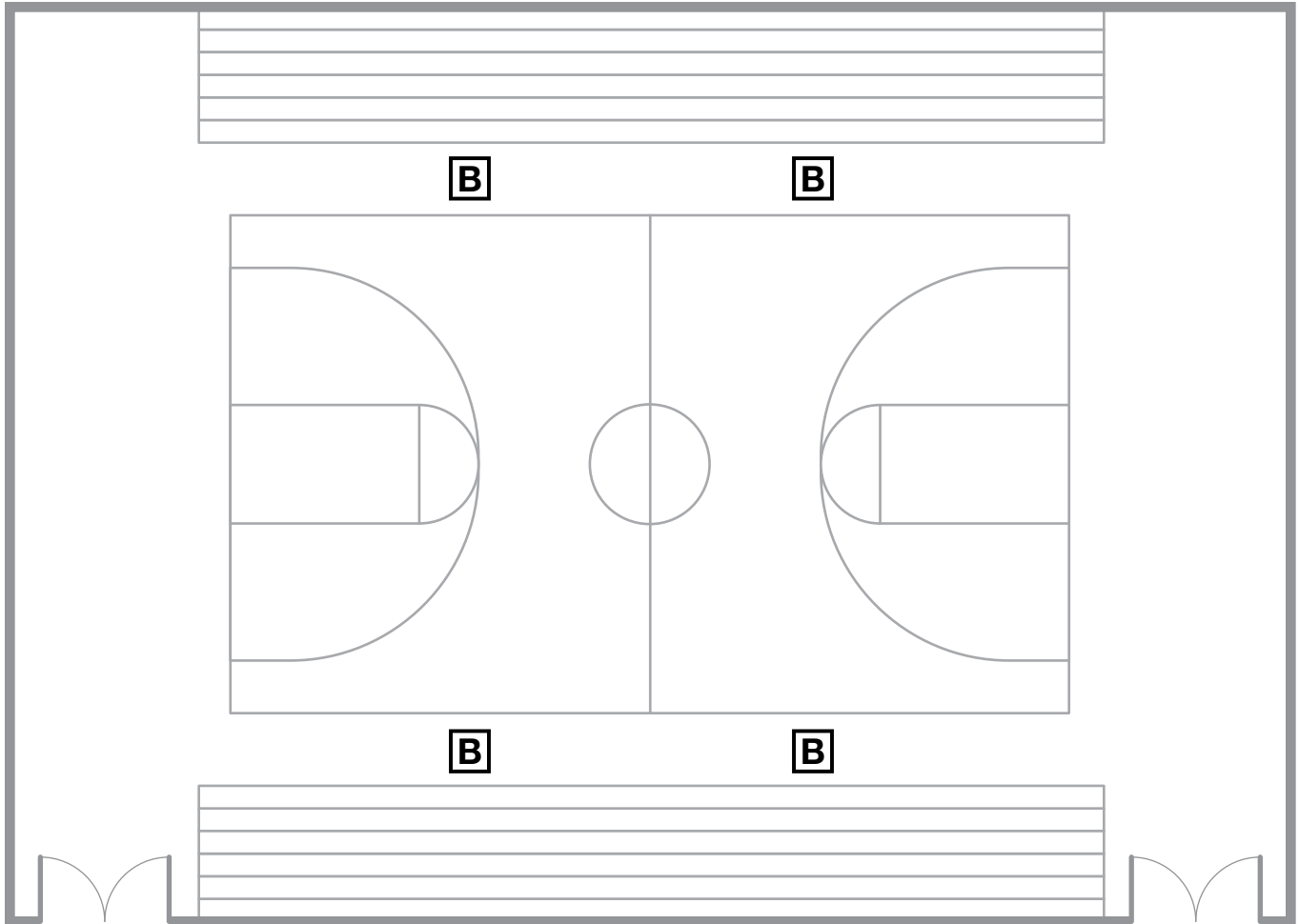

### Example 2

In this example, we used our high bay occupancy sensors. These sensors are made specifically for use in high ceiling applications. As with other ceiling sensors, you'll want to try to keep them close to the wall with the doors to avoid looking out into the adjacent space. These sensors have a fairly large coverage area, so be sure to take that into account when selecting the number and location of the sensors.

**B** = High bay sensor



# Sensor placement—utility rooms

Utility rooms are often overlooked when considering light control, but can benefit greatly from occupancy sensors, which ensure that the lights in a rarely occupied space are off as often as possible. In-wall sensors can often cover the room and are a quick and easy standalone solution.

## **Helpful hints**

- Make sure that tall furniture and equipment won't obstruct the sensor's view of the room.
- Note any focus areas or work areas in the space.
- Make sure that the sensor's view of the room isn't blocked by the door when it's open.
- Try to avoid having the sensor looking out the door of the space. Keep ceiling-mounted sensors close to the wall with the door on it. If you're using a wall-mounted sensor try to mount the sensor on the wall with the door.
- Make sure that the sensor's view of the entrance will not be blocked by the door when it's open. You might need to use another sensor to help cover the entrance.
- Don't mount sensors close to air vents, as the vibration and air flow can reduce the effectiveness of the sensor (PIR sensors should not be within 4 ft of an air vent, and ultrasonic sensors should not be within 6 ft of an air vent).

## Utility room examples

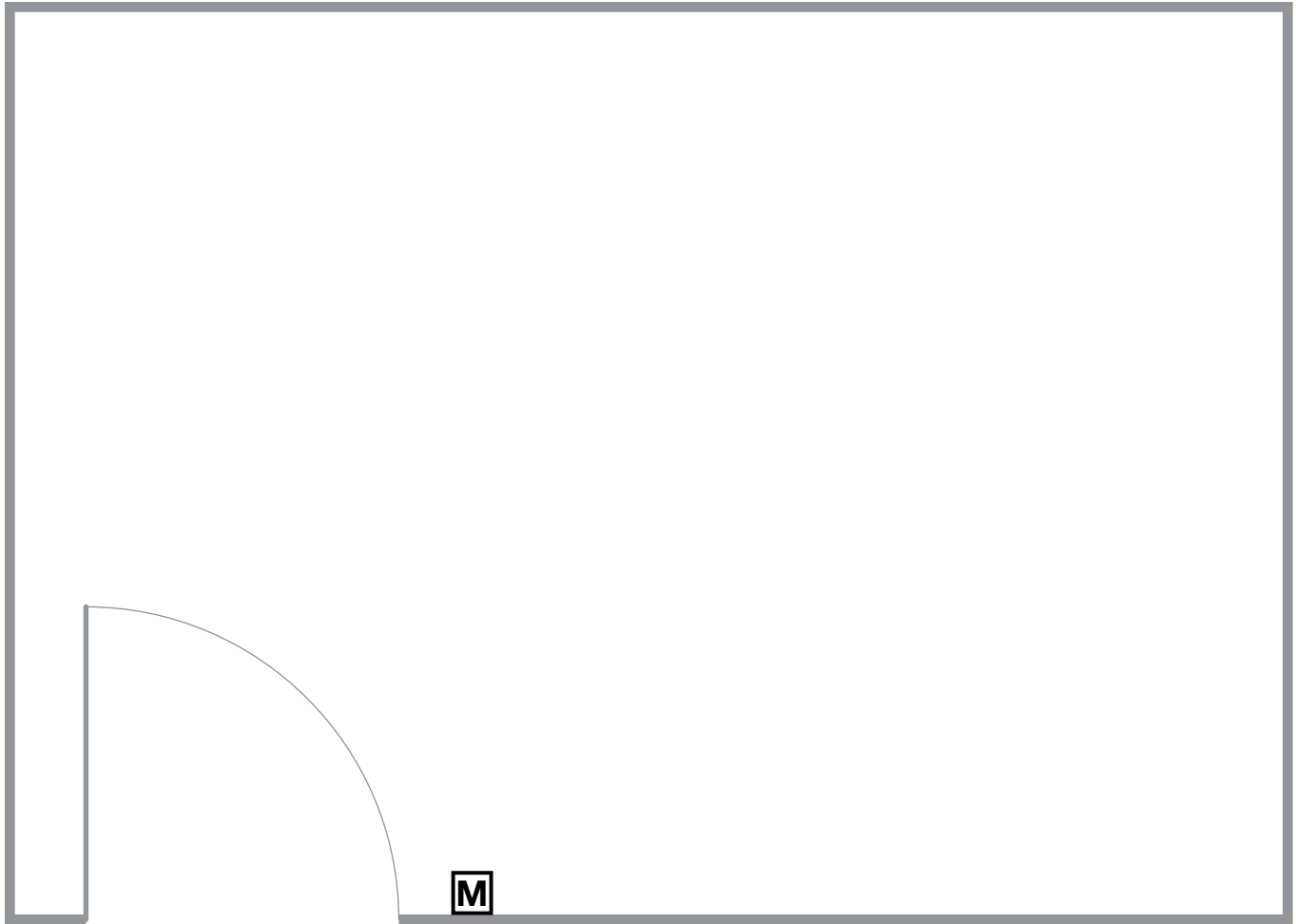

### Example 1

In this example there isn't any equipment obstructing the view in the room, so we used an in-wall sensor as a standalone solution. This sensor has a good view of the entrance as well as the rest of the space. If a system solution is required, you could use a ceiling mounted sensor.

**M** = Maestro® in-wall sensor



## Utility room examples

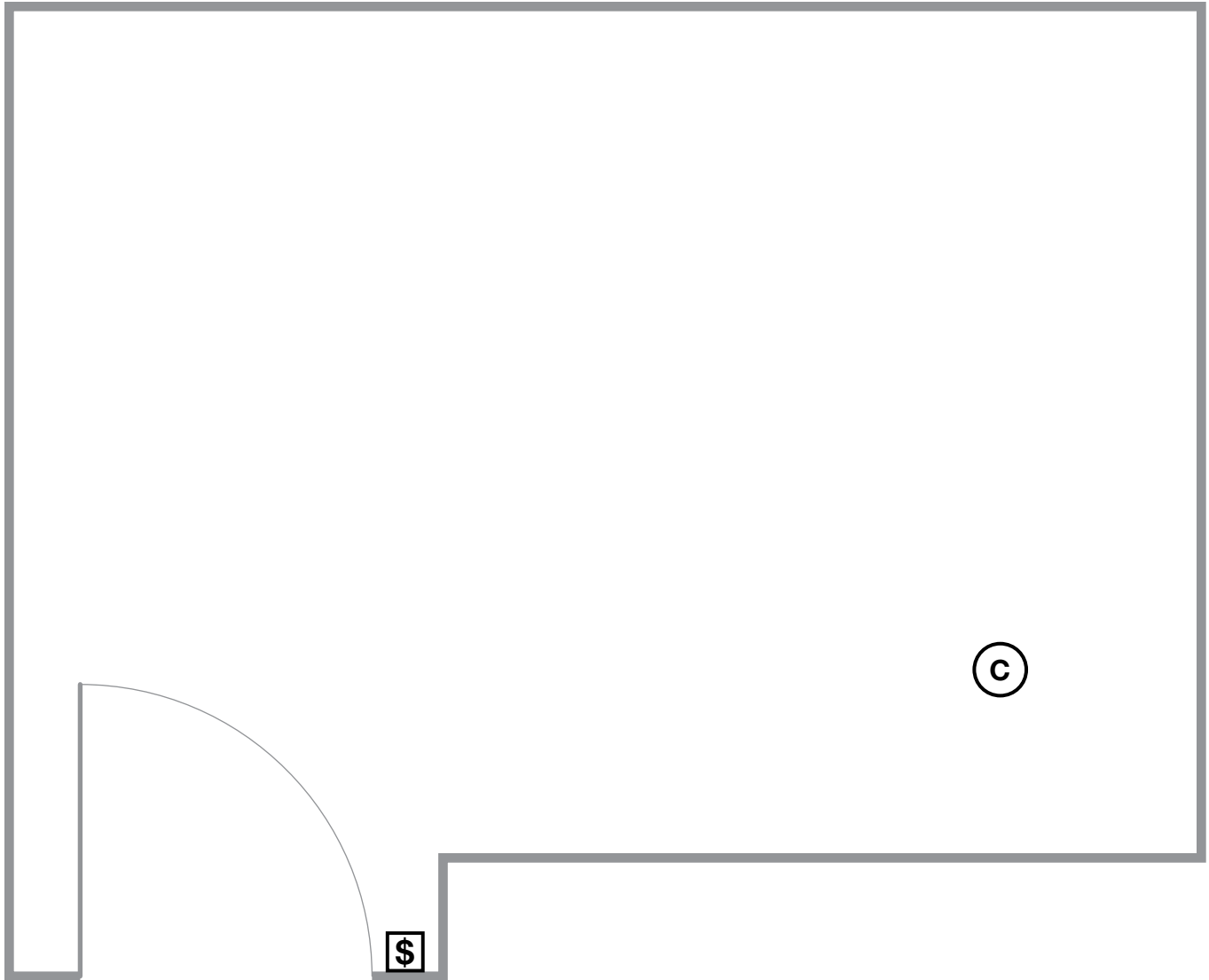

### Example 2

Here we chose a ceiling mounted sensor because the light switch placement in the recessed entrance eliminates the possibility of an in-wall sensor. The sensor has a clear view of the door and is away from any air vents or fans. Because the utility room door remains closed when the space is unoccupied, we don't have to worry about the sensor seeing out the door into the adjacent space.

**\$** = Wall control

**C** = Ceiling sensor



Designing an occupancy sensor layout for a data center can be challenging. The server racks tend to be tall (obstructing sensor views) and the people in the space typically don't move around much. In addition, the hot, moving air in the space can pose an issue for both ultrasonic and PIR technologies. When designing the layout for these spaces, it's important to remember to keep all of these factors in mind.

## **Helpful hints**

- Don't mount sensors close to air vents, as the vibration and air flow can reduce the effectiveness of the sensor (PIR sensors should not be within 4 ft of an air vent, and ultrasonic sensors should not be within 6 ft of an air vent).
- Warm, moving air near the ceiling can be an issue for ceiling-mounted sensors. For that reason, we normally try to avoid using ceiling sensors in this application.
- Use a lower sensitivity for the sensors in this space to help negate the effect of the warm, moving air.

## Data center example

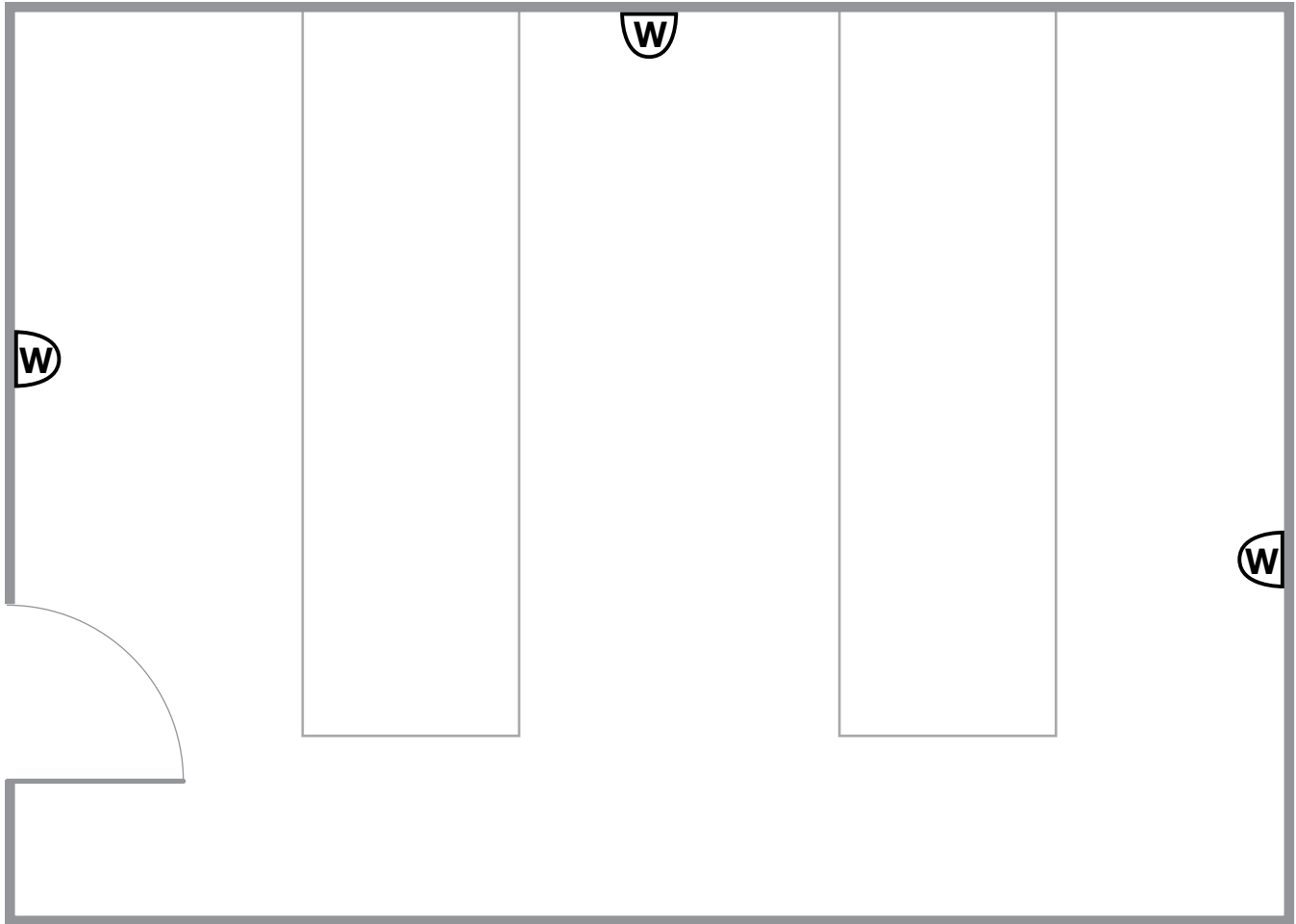

### Example 1

In this example, we're using wall mounted sensors, and we're going to set them to a lower sensitivity setting than we would in most situations. The lower sensitivity helps overcome issues caused by the warm, moving air. We do want to make sure that the sensors are covering the aisles completely and also that the sensors are positioned to sufficiently cover the doorway and main walkway. The sensor near the door should be mounted high enough that the door will not block the sensor's view while in an open position. Also, because data center doors are normally closed for security purposes, we don't have to be concerned with the sensor looking into the adjacent space.

 = Wall sensor

# Sensor placement—kitchen areas/break rooms

When looking at kitchens and break rooms, it's important to make sure that the entrance is covered and the sensors aren't looking into the adjacent space. It's also important to take note of any furniture in the room that might obstruct the sensor's view of the space. For an enclosed kitchen/break room, an in-wall sensor can be a viable standalone solution. When dealing with an open kitchen/break room attached to a hallway, using a corner-mounted sensor or ceiling-mounted sensor with a mask, which limits the sensor's field of view, can help prevent picking up the adjacent space.

## Helpful hints

- Make sure that tall furniture and equipment won't obstruct the sensor's view of the room.
- Use armature mounts to gain more flexibility for a sensor to help ensure that it doesn't look into other areas.
- Make sure an in-wall or wall-mounted sensor's view of the room isn't blocked by the door when the door is open.
- Make sure that the sensor's view of the entrance won't be blocked by the door when it's open. You might need to use another sensor to help cover the entrance.
- Don't mount sensors close to air vents, as the vibration and air flow can reduce the effectiveness of the sensor (PIR sensors should not be within 4 ft of an air vent, and ultrasonic sensors should not be within 6 ft of an air vent).



## Kitchen area/break room examples

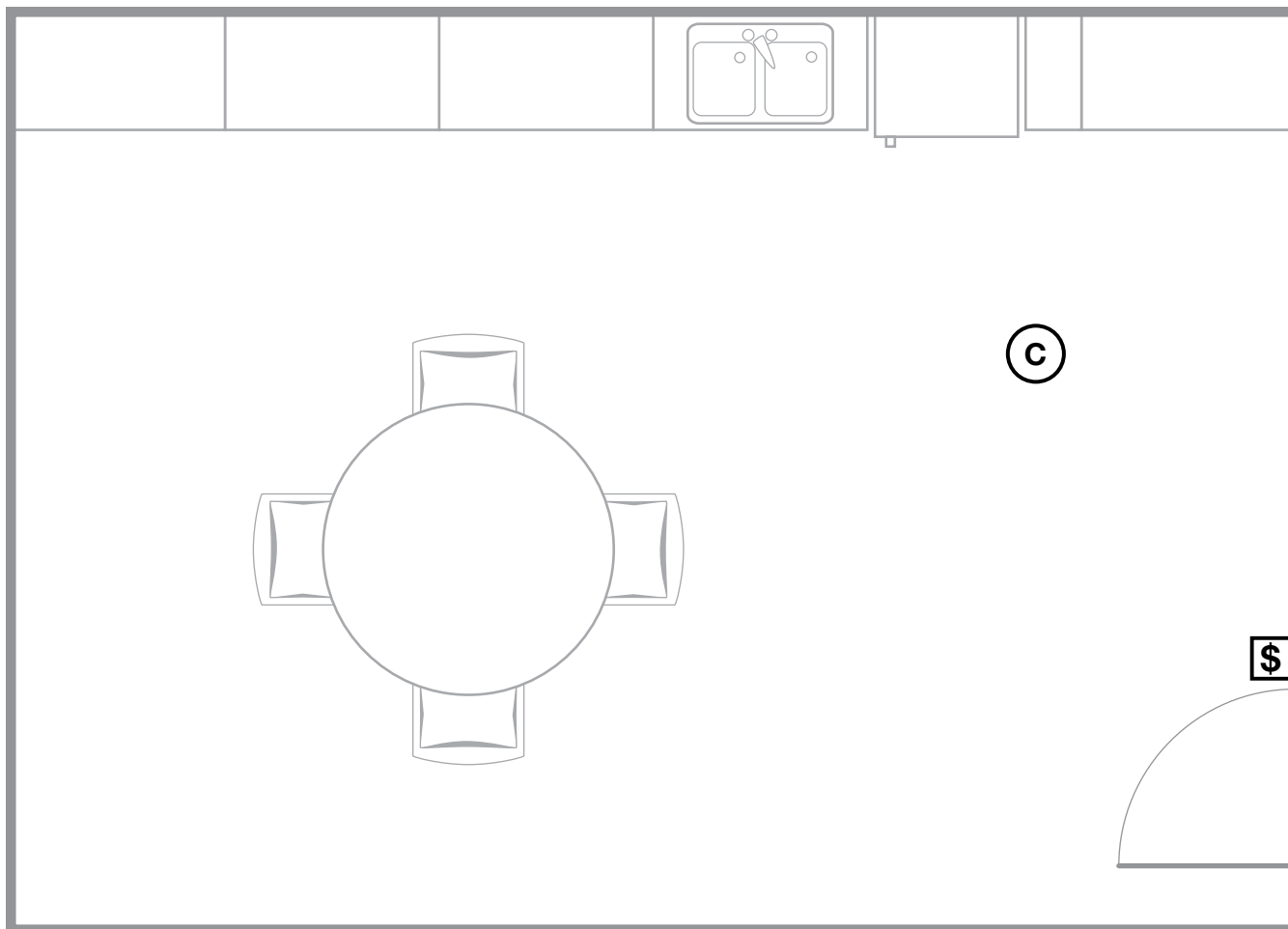

### Example 1

In this example we have a closed kitchen/break room. The door closes automatically, so it's shut unless someone is walking through it. Because there isn't any chance of the sensor seeing out of the space, we can place a ceiling-mounted sensor anywhere that it can see the door and main area, as long as it's not close to an air vent.

**C** = Ceiling sensor

**\$** = Wall control

## Kitchen area/break room examples

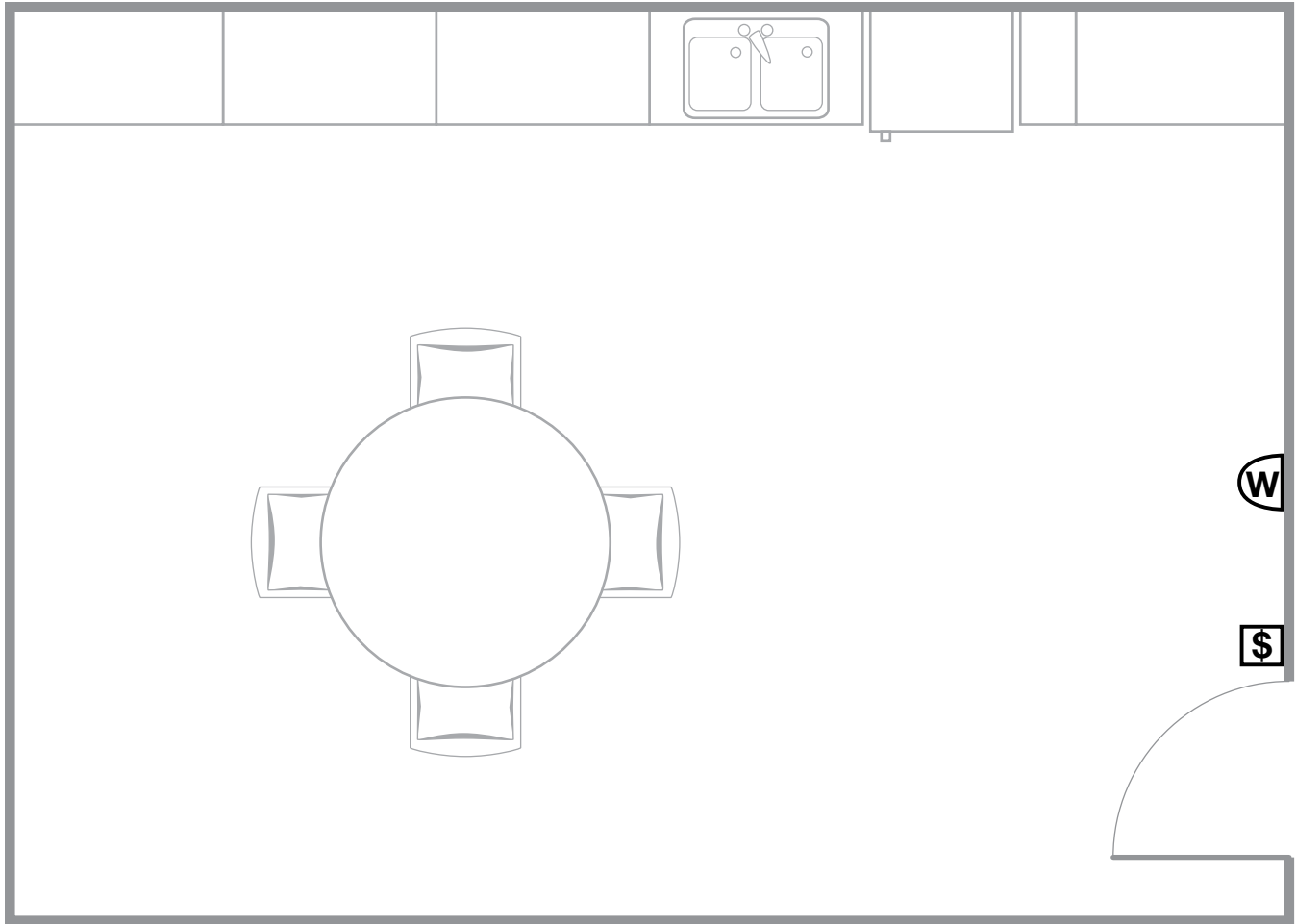

### Example 2

This example is much like the previous example, except the door doesn't close automatically, so the sensor may look out of the space. Due to that, a wall-mounted sensor becomes the best option to cover the space. Placing a wall-mounted sensor on the same wall with the door will provide coverage of the space and the entrance without having the sensor looking into the adjacent space when the door is open.

 = Wall sensor

 = Wall control

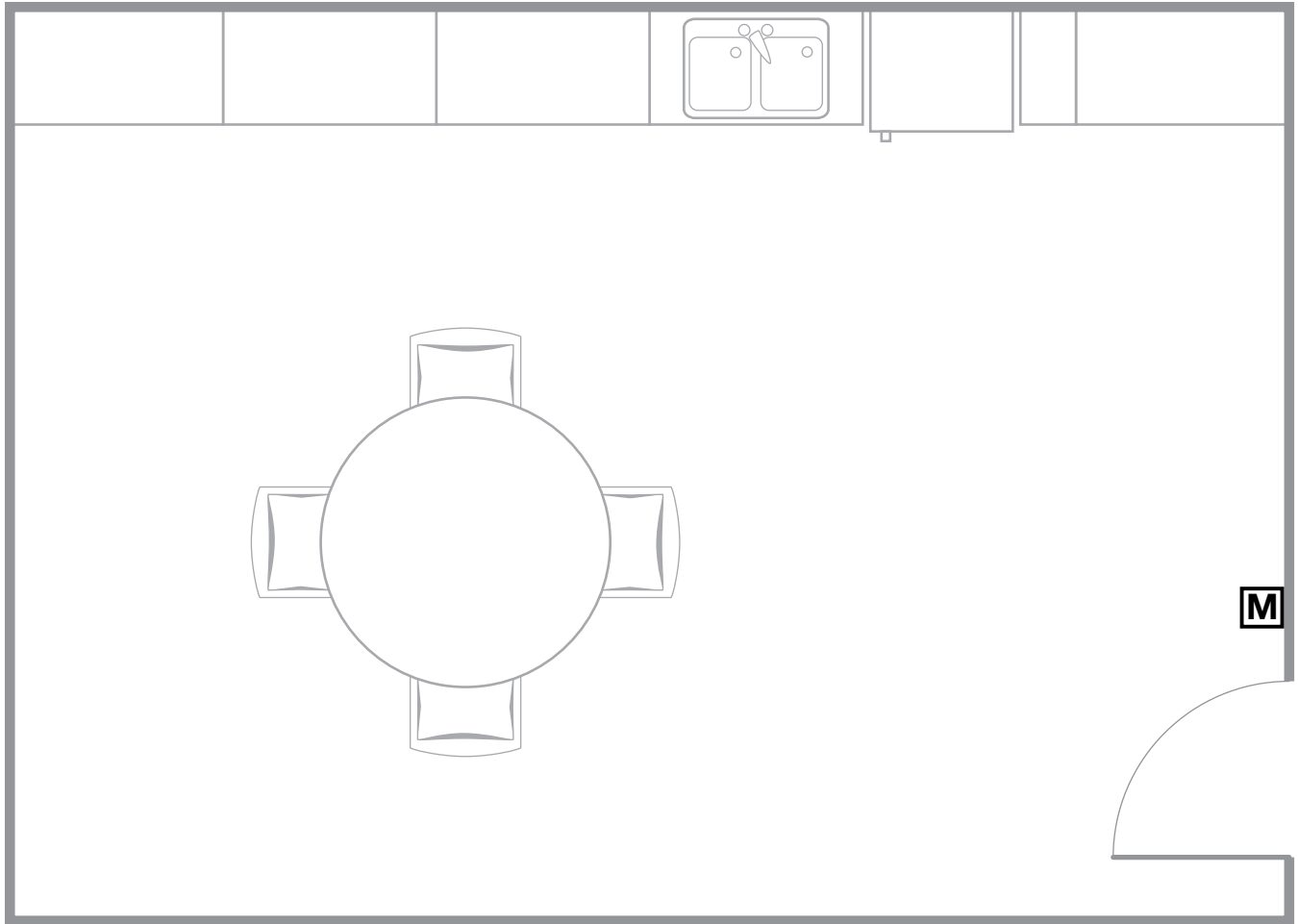

### Example 3

Here, the light switch is located in a position that allows us to use an in-wall sensor. The in-wall sensor provides complete coverage of the space and the entrance, and doesn't look out into the adjacent space.

**M** = Maestro® in-wall sensor



## Kitchen area/break room examples

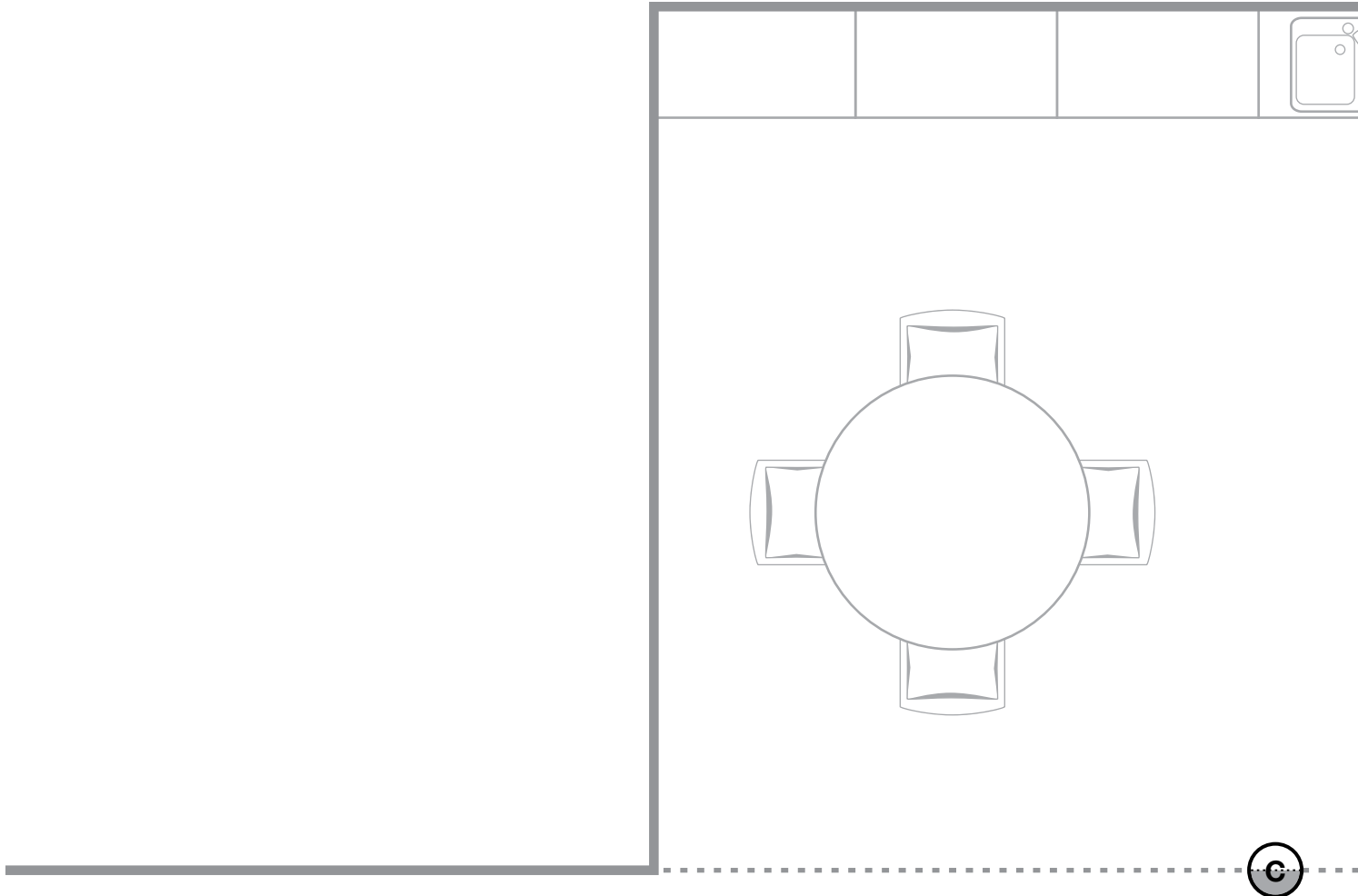

### Example 4

This example has a kitchen/break room that is open to the hallway, so it's very important to get the selection and placement of the sensor right to ensure that the sensor acts only for this area, independent of the hallway. We used a ceiling-mounted sensor with a mask over the lens in order to limit the view of the sensor to the 180 degrees in the space. Because of the mask, we placed the sensor in line with the two corners of the room and the hallway, and away from any air vents.

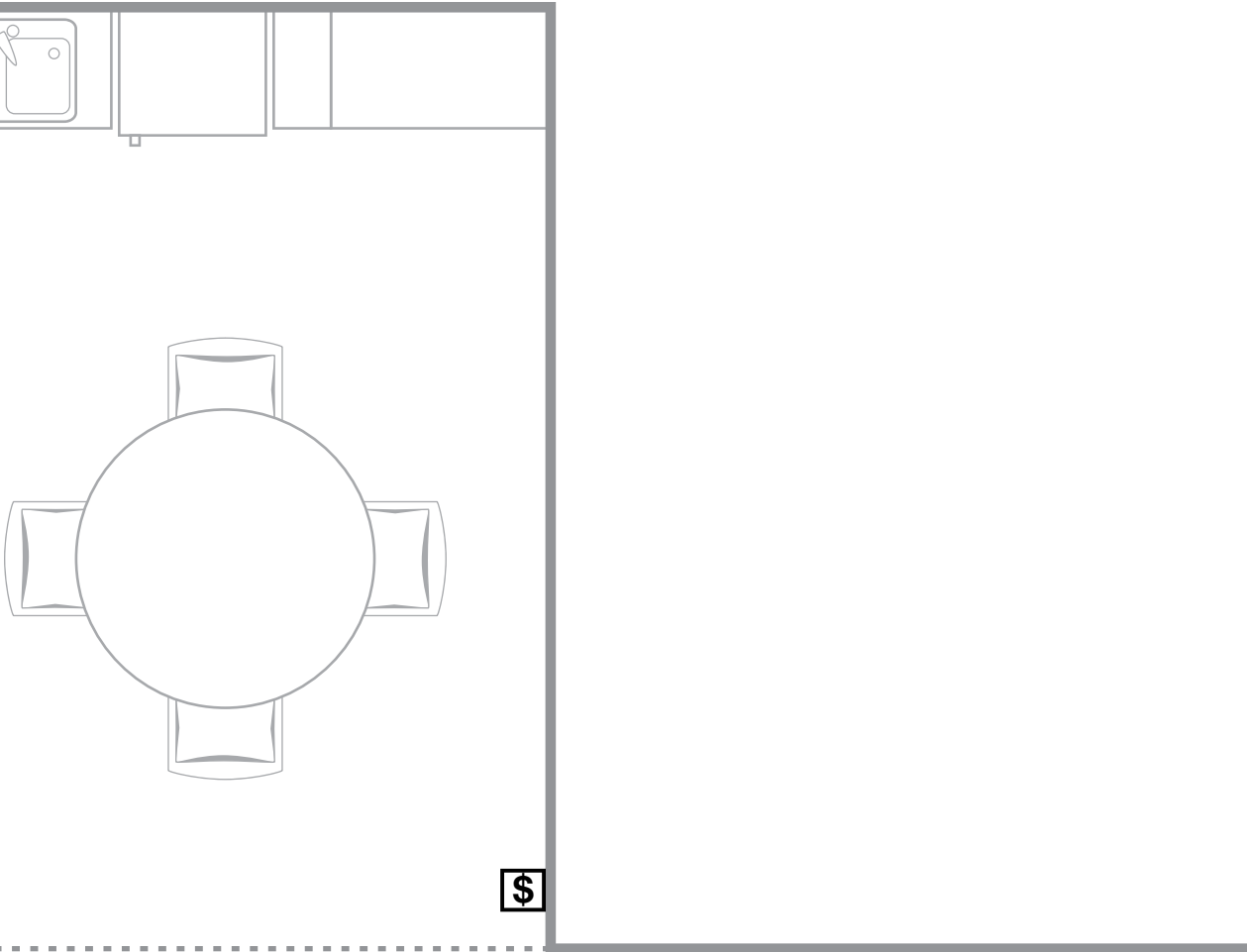

**C** = Ceiling sensor with mask

**\$** = Wall control

## Kitchen area/break room examples

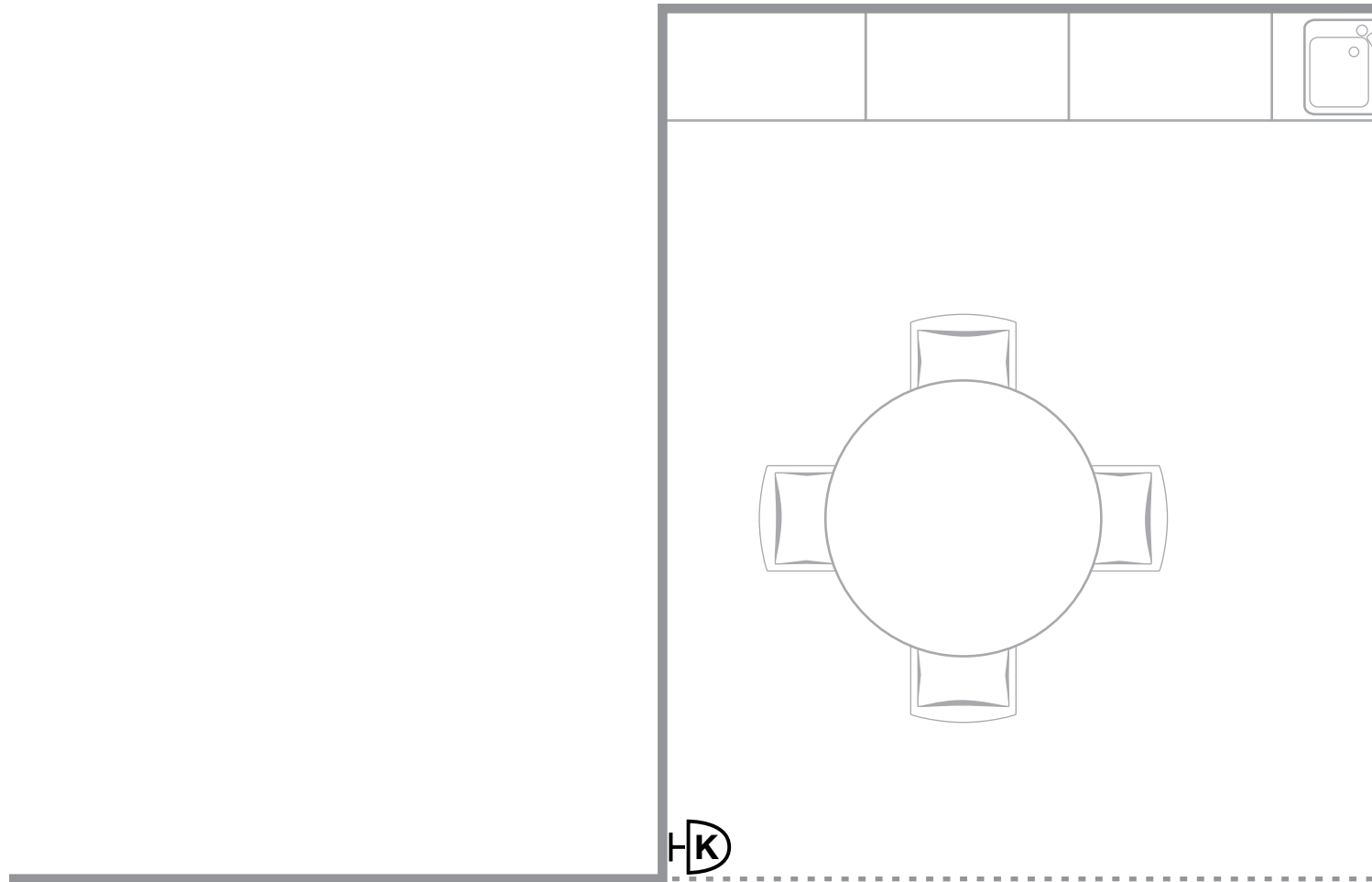

### Example 5

This example is identical to the previous example; however, we used a corner-mount sensor instead of ceiling-mount. The corner-mount sensor is mounted on an armature in one of the corners. The sensor will need to be adjusted and turned so that the sensor's 90 degree viewing range points into the space and doesn't look into the hallway. Trial and error may be required to get the positioning of the sensor correct.

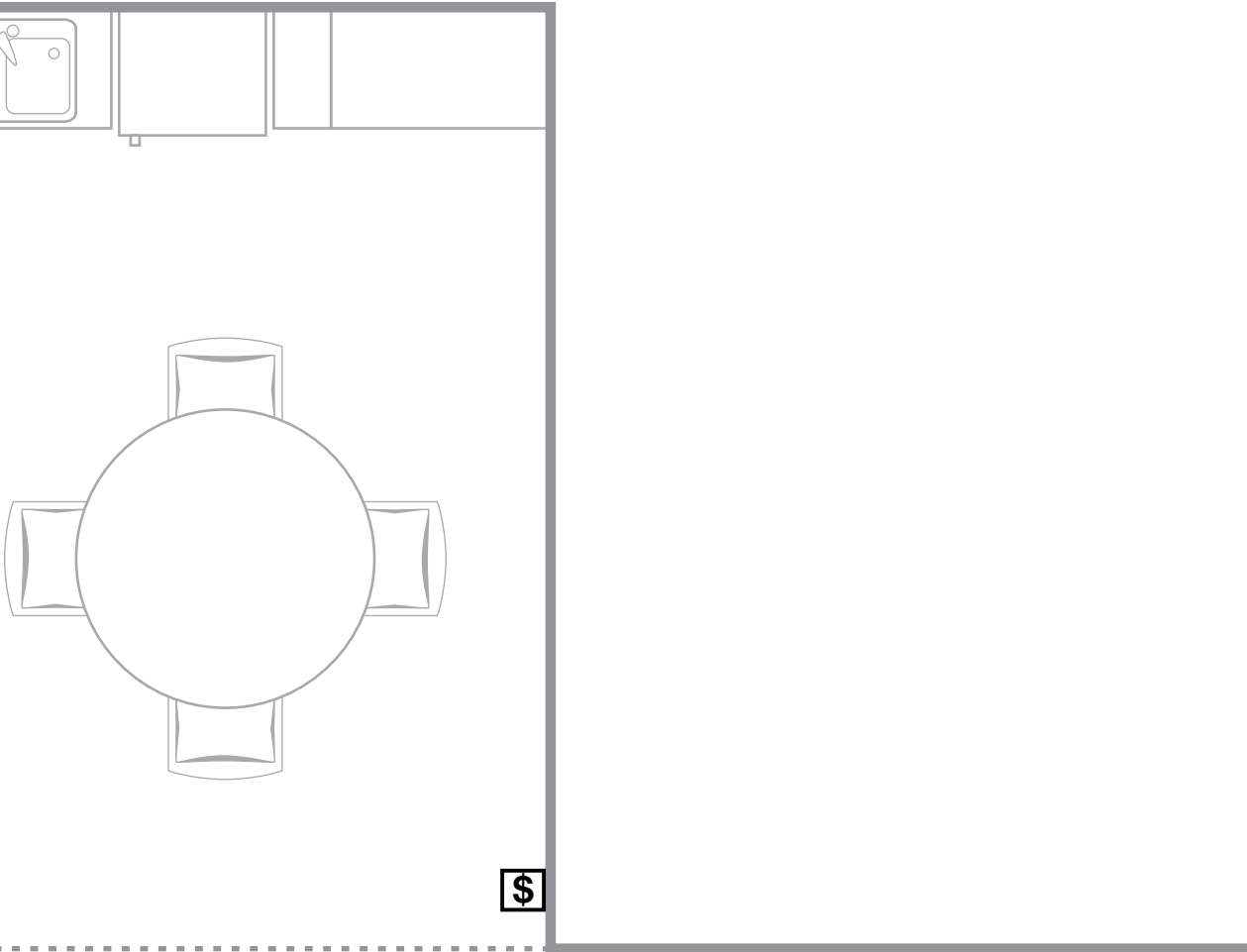

┌ = Armature

⌒K = Corner sensor

Ⓢ = Wall control

## Features and capacities

- PIR detection with exclusive Lutron XCT™ technology for fine-motion detection
- Adjustable timeout—  
1, 5, 15, or 30 minutes
- Occupancy/vacancy (auto-on/auto-off or manual-on/auto-off) or vacancy-only (manual-on/auto-off) versions available
- Dual-circuit model only—partial-on model available (circuit 1 set to occupancy/vacancy and circuit 2 set to vacancy only)
- Vacancy models meet California Title 24 Section 119 (j) requirements
- Sensors must have unobstructed view and line-of-sight to room occupants
- 180° field-of-view
- Up to 30 ft x 30 ft major motion and 20 ft x 20 ft minor motion coverage
- High-low sensitivity adjustment
- Versions available:
  - 2 A and 5 A, 120 V switch
  - 6 A, 120-277 V switch
  - 6 A per circuit, 120-277 V dual switch
  - C•L® dimmer

## Dimensions and mounting

- Width: 2.94 in (75 mm)  
Height: 4.69 in (119 mm)  
Depth: .30 in (7.6 mm)
- Mounts in standard 1-gang U.S. backbox

## Direct load type compatibility

- Dimmer—incandescent/halogen
- 2 A switch controls—incandescent, halogen, MLV, ELV, LED, and non-dim fluorescent
- 5 A, 6 A, and dual-circuit switch controls—incandescent, halogen, MLV, ELV, LED, non-dim fluorescent, and general purpose fans
- C•L dimmer controls—dimmable incandescent, halogen, certain dimmable CFLs and LEDs. See the approved dimmable bulb list.



Shown actual size

## Model numbers

### **Switch: 120V, 2A lighting**

occupancy/vacancy sensor MS-OPS2-XX<sup>1,2</sup>

### **Switch: 120V, 5A lighting, 3A fan (1/10HP @ 120V)**

occupancy/vacancy sensor MS-OPS5M-XX<sup>1,2</sup>

### **Digital fade dimmer:**

#### **120V, 600W lighting, 150W C•L**

occupancy/vacancy sensor MSCL-OP153M-XX<sup>1,2</sup>

### **Dual-voltage switch: 120-277V, 6A lighting, 3A fan (120V only)**

occupancy/vacancy sensor MS-OPS6M2-DV-XX<sup>1,2</sup>

### **Dual-circuit dual-voltage switch: 120-277V, 6A lighting, 4.4A fan (120V only) per circuit**

occupancy/vacancy sensor MS-OPS6-DDV-XX<sup>1,3</sup>

1: Gloss and Satin color codes

2: Vacancy-only version, replace "O" with "V"

3: Partial-on version, replace "O" with "P"

## Sensor coverage

**Top view/Plan view**

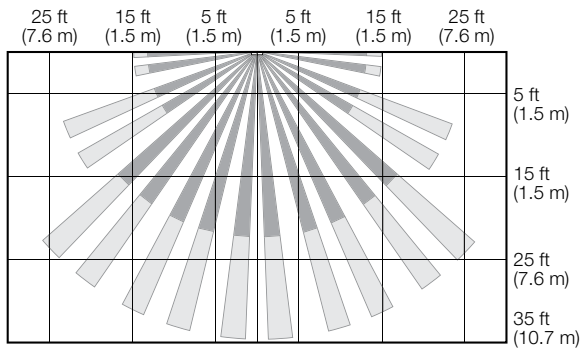

**Vertical view**

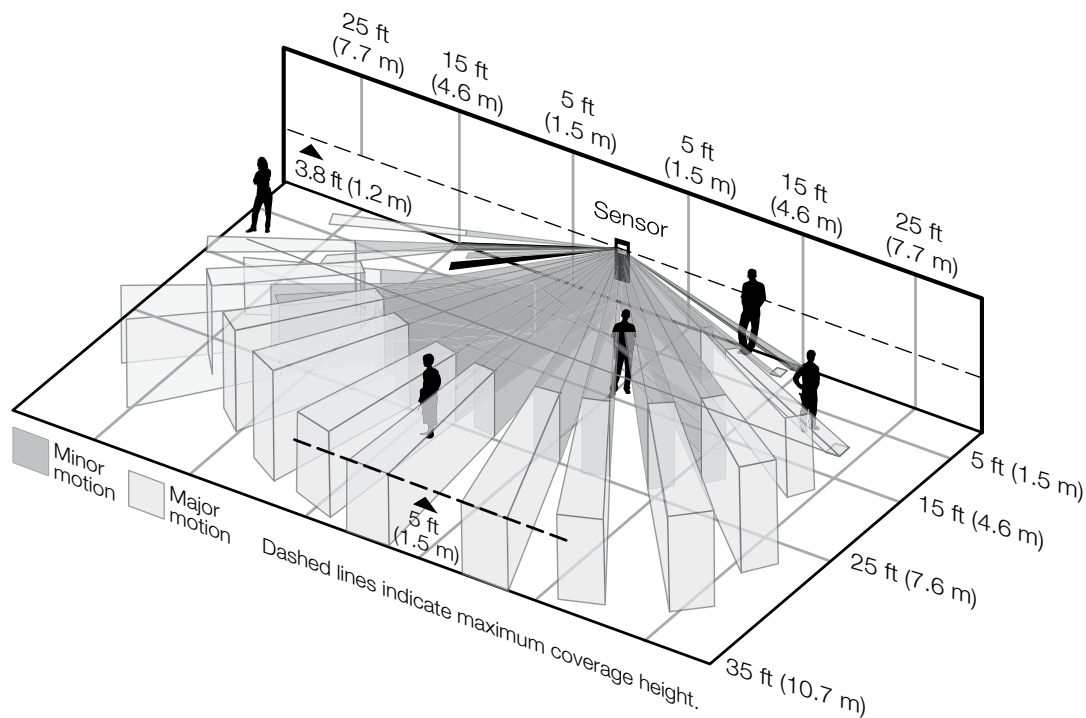
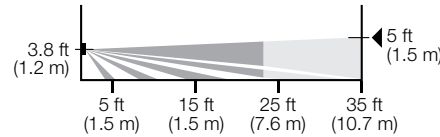

## Sensor performance

- The sensor's ability to detect motion requires line-of-sight to room occupants. The sensor must have an unobstructed view of the room.
- Hot objects and moving air currents can affect the sensor's performance.
- The sensor's performance depends on a differential between the ambient room temperature and the temperature of room occupants. Warmer rooms may reduce the sensor's ability to detect occupants.

## Features and capacities

- PIR and ultrasonic motion detection with exclusive Lutron XCT™ technology for very fine motion detection
- Adjustable timeout—1, 5, 15, or 30 minutes
- Occupancy/vacancy (auto-on/auto-off or manual-on/auto-off) or vacancy-only (manual-on/auto-off) versions available
- Dual-circuit model only—partial-on model available (circuit 1 set to occupancy/vacancy and circuit 2 set to vacancy only)
- Vacancy models meet California Title 24 Section 119 (j) requirements
- 180° field-of-view
- Up to 30 ft x 30 ft major motion and 20 ft x 20 ft minor motion coverage
- Sensitivity adjustments for ultrasonic and PIR. Neutral wire required.
- Versions available:
  - 6 A, 120 -277 V switch
  - 6 A per circuit, 120 -277 V dual switch

## Dimensions and mounting

- Width: 2.94 in (75 mm)  
Height: 4.69 in (119 mm)  
Depth: .30 in (7.6 mm)
- Mounts in standard 1-gang U.S. backbox

## Direct load type compatibility

- 6A, and dual-circuit switch controls—incandescent, halogen, MLV, ELV, LED, non-dim fluorescent, and general purpose fans



Shown actual size

## Model numbers

**Dual-voltage switch: 120-277 V, 6 A lighting, 4.4 A fan (120 V only)**

occupancy/vacancy sensor	MS-B102-XX
--------------------------	------------

**Dual-voltage vacancy switch: 120-277 V, 6 A lighting, 4.4 A fan (120 V only)**

occupancy/vacancy sensor	MS-B102-V-XX
--------------------------	--------------

**Dual-circuit dual-voltage switch: 120-277 V, 6 A lighting, 4.4 A fan (120 V only) per circuit**

occupancy/vacancy sensor	MS-B202-XX
--------------------------	------------



### Sensor performance

- The sensor performs best with an unobstructed view of the room.
- Hot objects and moving air currents can affect the sensors performance. The sensor performs best when located 6 ft (1.8 m) or more away from hot objects or moving air currents.
- PIR performance depends on a differential between the ambient room temperature and the temperature of room occupants. Warmer rooms may reduce the sensors ability to detect occupants.
- The ultrasonic performance can be affected by air currents and moving objects. Consider the effects of fans, HVAC vents, open windows, or moving objects when installing the sensor.

#### NEMA WD7 Coverage

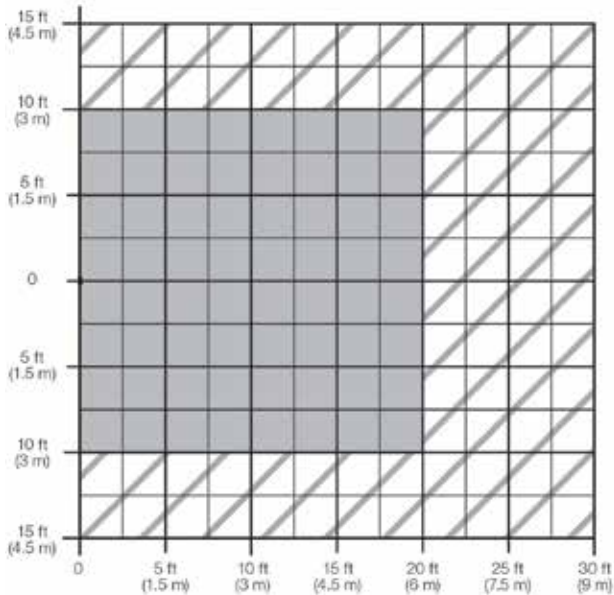
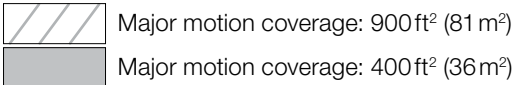

Test room dimensions: 37 ft x 38 ft (11.28 m x 11.6 m)  
 Test floor surface material: Carpet  
 Sensor coverage angle: 180°  
 Major motion coverage: Initial trigger motion detection  
 Minor motion coverage: Maintained motion detection

#### Passive Infrared Beam Diagram

(For Reference Only)

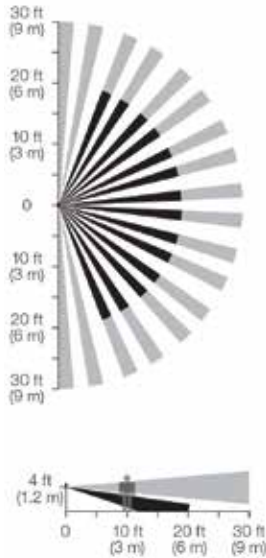

#### Ultrasonic Coverage

(For Reference Only)

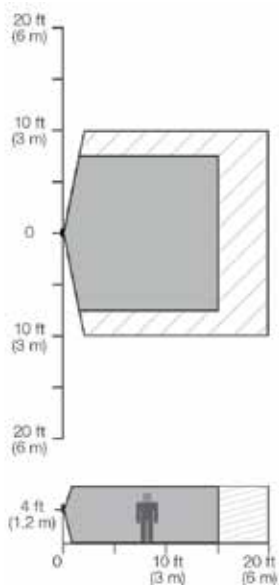



## Features and capacities

- Simple installation with no wiring
- Requires compatible receiving device (available separately)
- Occupancy/vacancy has auto-on/auto-off, manual on/auto-off or auto-on low light/auto-off control
- Vacancy model has manual on/auto-off control to meet California Title 24 section 119(j) requirements
- Adjustable timeout—1, 5, 15, or 30 minutes
- PIR motion detection with exclusive Lutron XCT™ technology for minor motion detection
- 360° field-of-view
- Battery included; 10-year battery life design
- For indoor use only, temperature: 32° F–104° F (0° C–40° C)

## Dimensions and mounting

- Width: 3.57 in (91 mm)  
Depth: 1.30 in (33 mm)
- Mount within 60 ft (18 m) line-of-sight or 30 ft (9.1 m) through walls, of the receiving devices
- Recommended for 8–12 ft (2.4–3.7 m) ceilings
- Can be recess or surface-mounted to solid or drop ceilings (recess mounting bracket sold separately: part number LRF-CRMK-WH)

## Communication

- Communicates via Lutron's reliable Clear Connect® Radio Frequency (RF) technology to other Lutron wireless devices
- Operates at 434MHz



Shown actual size

## Model numbers

### Wireless occupancy/vacancy sensors

360° ceiling-mount (434 MHz)

occupancy/vacancy	LRF2-OCR2B-P-WH
vacancy	LRF2-VCR2B-P-WH

Visit [www.lutron.com](http://www.lutron.com) for international models

## Accessories

10 removable adhesive strips	
10 PIR lens masks	L-CMDPIRKIT
ceiling mount adapter	LRF-CRMK-WH
ceiling mounted sensor wire guard	WGOMNI

See page 88 for complete list of accessories.

# Sensor coverage

**Sensor coverage pattern** 9ft (2.74 m) ceiling shown

**Top view/Plan view**

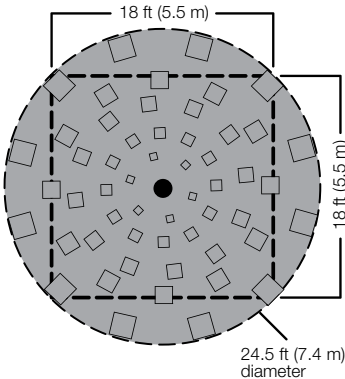

**Vertical view**

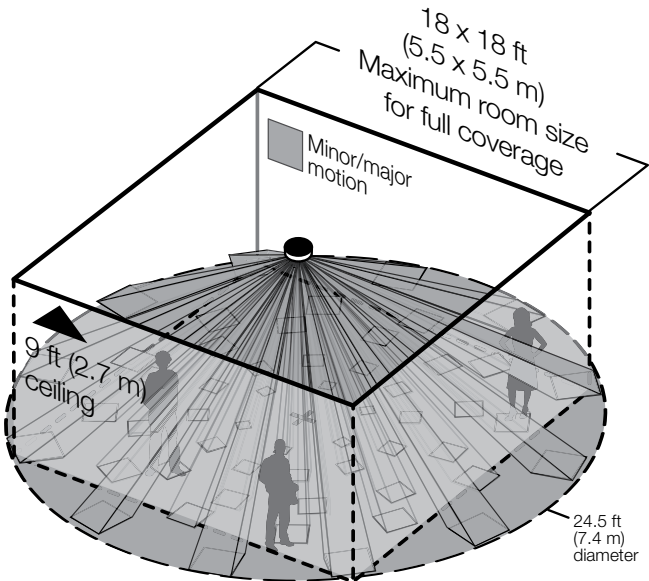
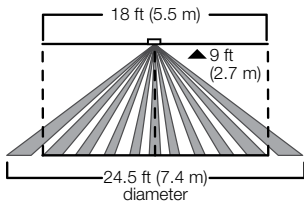

## Detection range for minor motion

Ceiling height	Maximum room dimensions for complete floor coverage	Square feet
8 ft (2.4 m)	18 x 18 ft (5.5 x 5.5 m)	324 ft <sup>2</sup> (30.2 m <sup>2</sup> )
9 ft (2.7 m)	20 x 20 ft (6.1 x 6.1 m)	400 ft <sup>2</sup> (37.2 m <sup>2</sup> )
10 ft (3.0 m)	22 x 22 ft (6.7 x 6.7 m)	484 ft <sup>2</sup> (44.9 m <sup>2</sup> )
12 ft (3.7 m)	26 x 26 ft (7.9 x 7.9 m)	676 ft <sup>2</sup> (62.4 m <sup>2</sup> )

### Features and capacities

- Models available with ultrasonic, PIR or dual-technology motion detection
- Self-adaptive sensors automatically adjust sensitivity and timing
- 360° and 180° field-of-view models available
- Coverages available from 450 ft<sup>2</sup>–2000 ft<sup>2</sup> (137 m<sup>2</sup>–610 m<sup>2</sup>) mounted at 8 ft to 12 ft (2.4 m–3.6 m) from floor
- Models available with additional dry contact closures
- For indoor use only, temperature: 32° F–104° F (0° C–40° C)
- Timeout range: 8-30 minutes

### Dimensions and mounting

- Diameter: 4.50 in (114 mm)  
Depth: 1.40 in (38 mm)
- Recommended for 8–12 ft (2.4–3.7 m) ceilings

### Communication and wiring

- Operates via low-voltage (PELV) standard wired communication
- 20-24 VDC, Class 2 (PELV) low-voltage wiring
- Uses two power draw units on the QS link, only if connected to the QS sensor module
- Power pack available



### Model numbers

#### Wired occupancy sensors

##### Dual-technology, self-adaptive

500 ft <sup>2</sup> (152 m <sup>2</sup> ), 180°	LOS-CDT-500-WH
additional contact closure	LOS-CDT-500R-WH
1,000 ft <sup>2</sup> (305 m <sup>2</sup> ), 180°	LOS-CDT-1000-WH
additional contact closure	LOS-CDT-1000R-WH
2,000 ft <sup>2</sup> (610 m <sup>2</sup> ), 360°	LOS-CDT-2000-WH
additional contact closure	LOS-CDT-2000R-WH

##### Ultrasonic

500 ft <sup>2</sup> (152 m <sup>2</sup> ), 180°	LOS-CUS-500-WH
1,000 ft <sup>2</sup> (305 m <sup>2</sup> ), 180°	LOS-CUS-1000-WH
2,000 ft <sup>2</sup> (610 m <sup>2</sup> ), 360°	LOS-CUS-2000-WH

##### PIR

450 ft <sup>2</sup> (137 m <sup>2</sup> ), 360°	LOS-CIR-450-WH
1,500 ft <sup>2</sup> (457 m <sup>2</sup> ), 360°	LOS-CIR-1500-WH

### Accessories

ceiling-mounted sensor wire guard      WGOMNI

See page 88 for complete list of accessories.

# Dual-technology sensor coverage

## LOS-CDT-500 models

Top view/Plan view

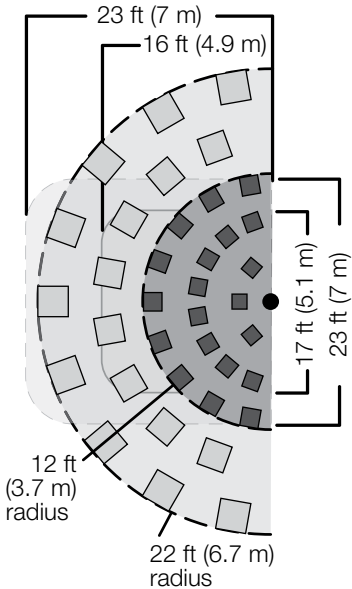

Vertical view

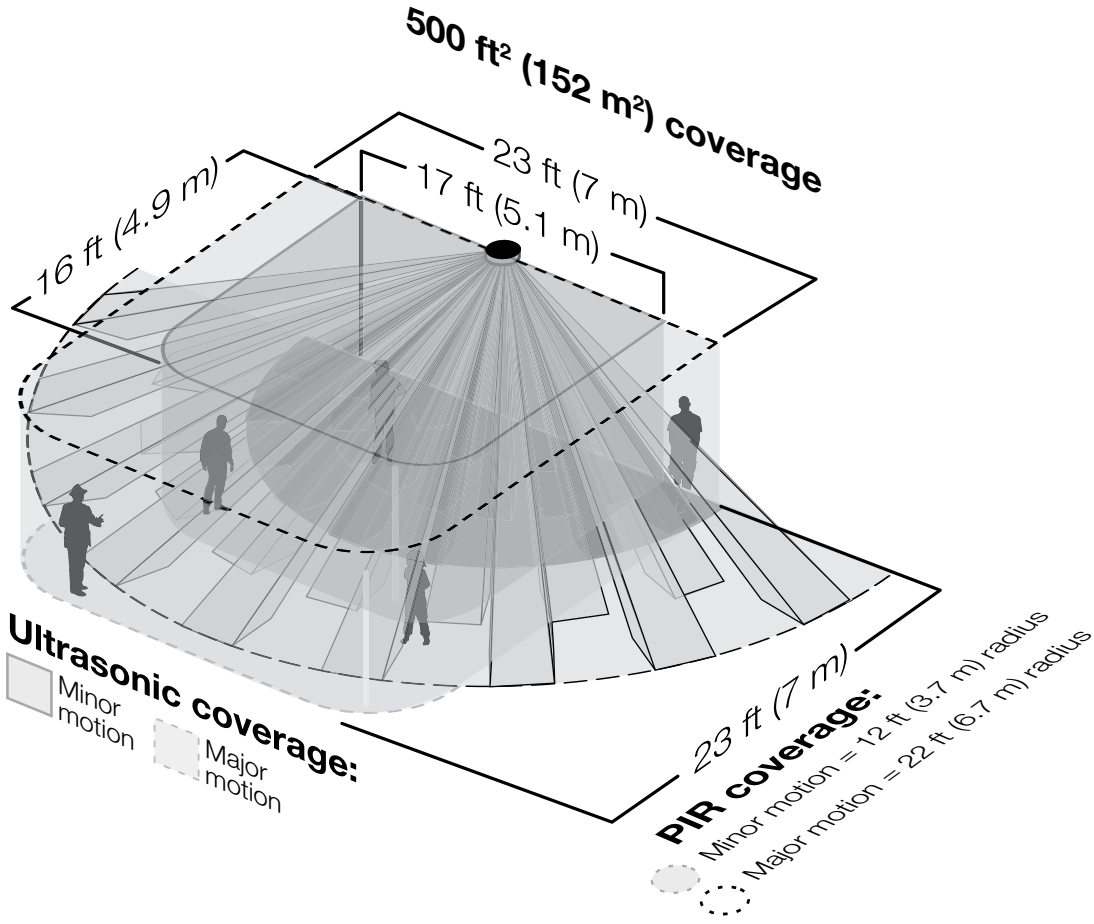
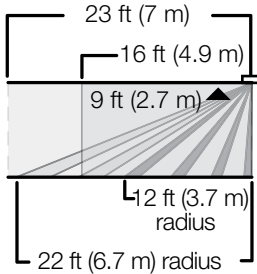

Dual-technology sensor coverage

LOS-CDT-1000 models

Top view/Plan view

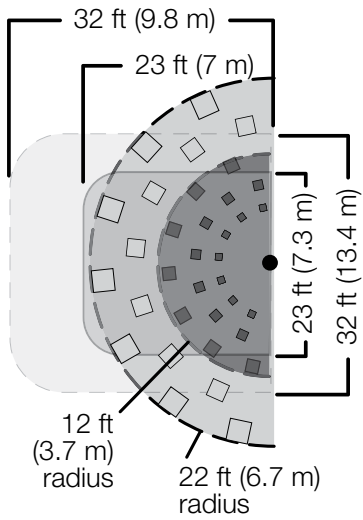

Vertical view

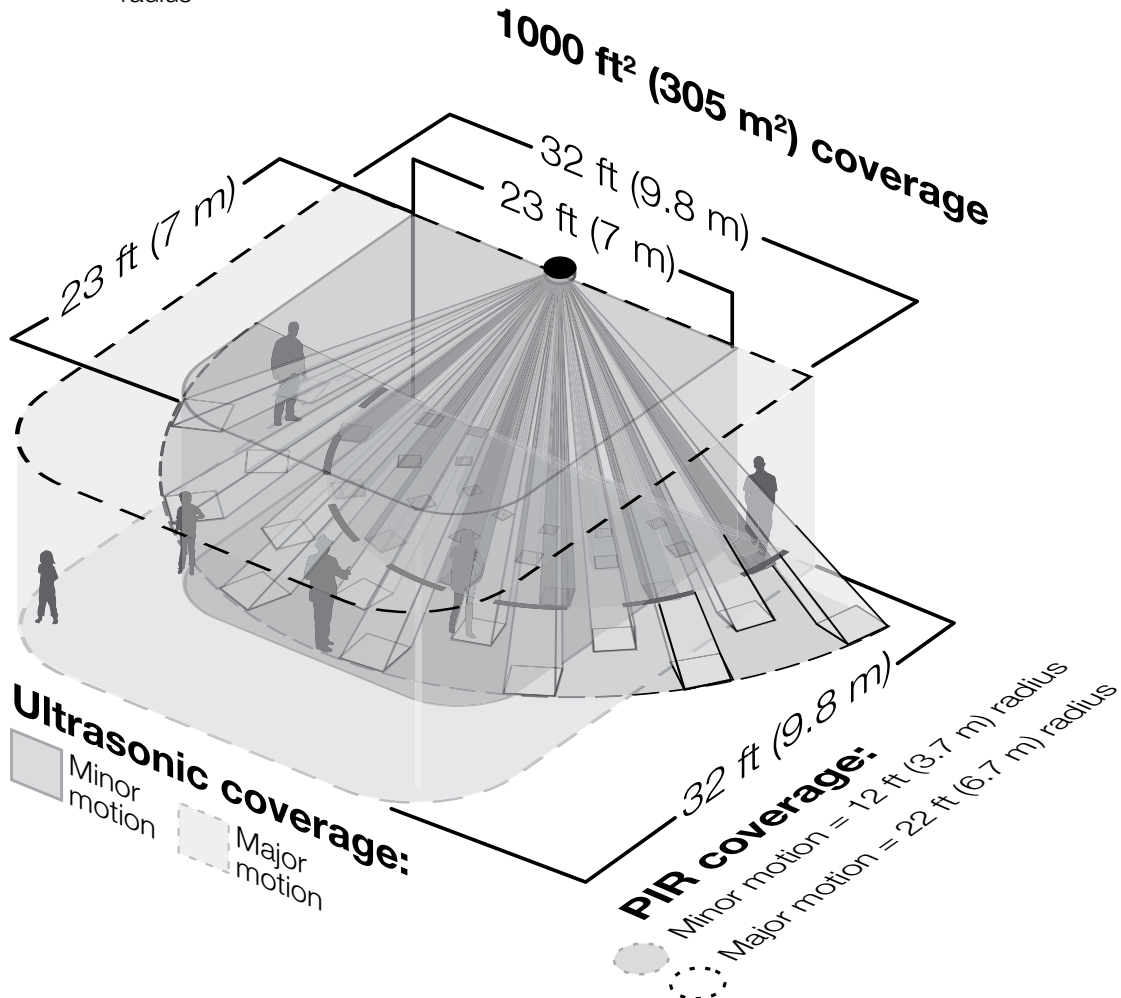
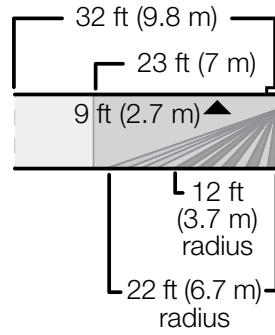



# Dual-technology sensor coverage

## LOS-CDT-2000 models

Top view/Plan view

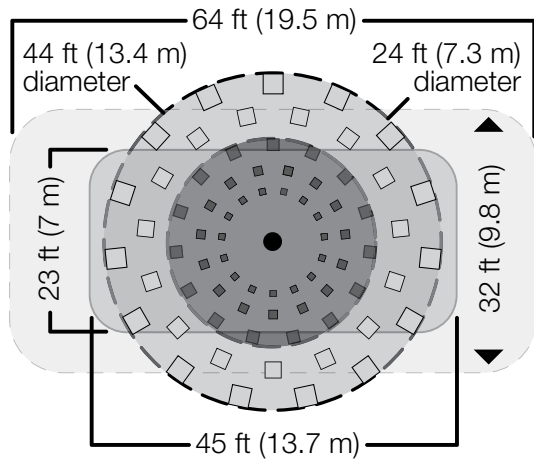

Vertical view

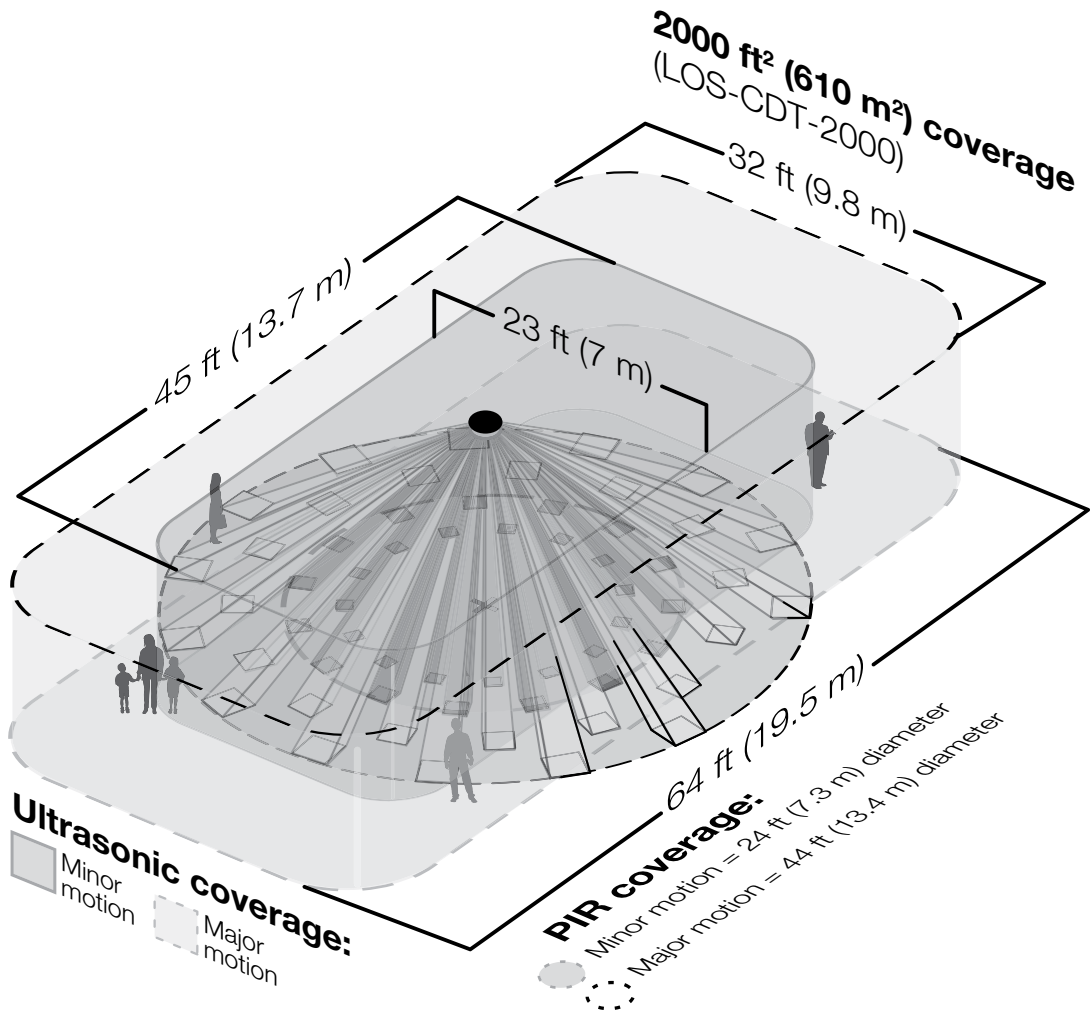
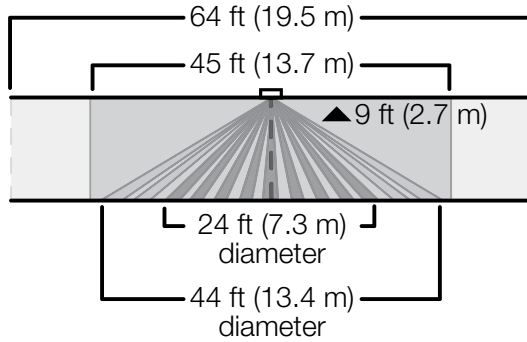

Ultrasonic sensor coverage

LOS-CUS-500 models

Top view/Plan view

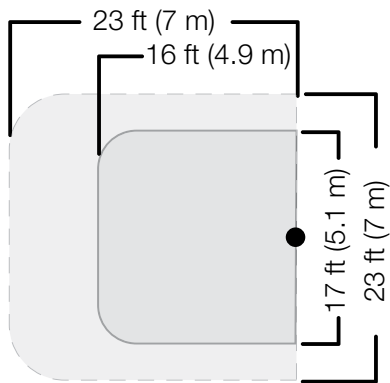

Vertical view

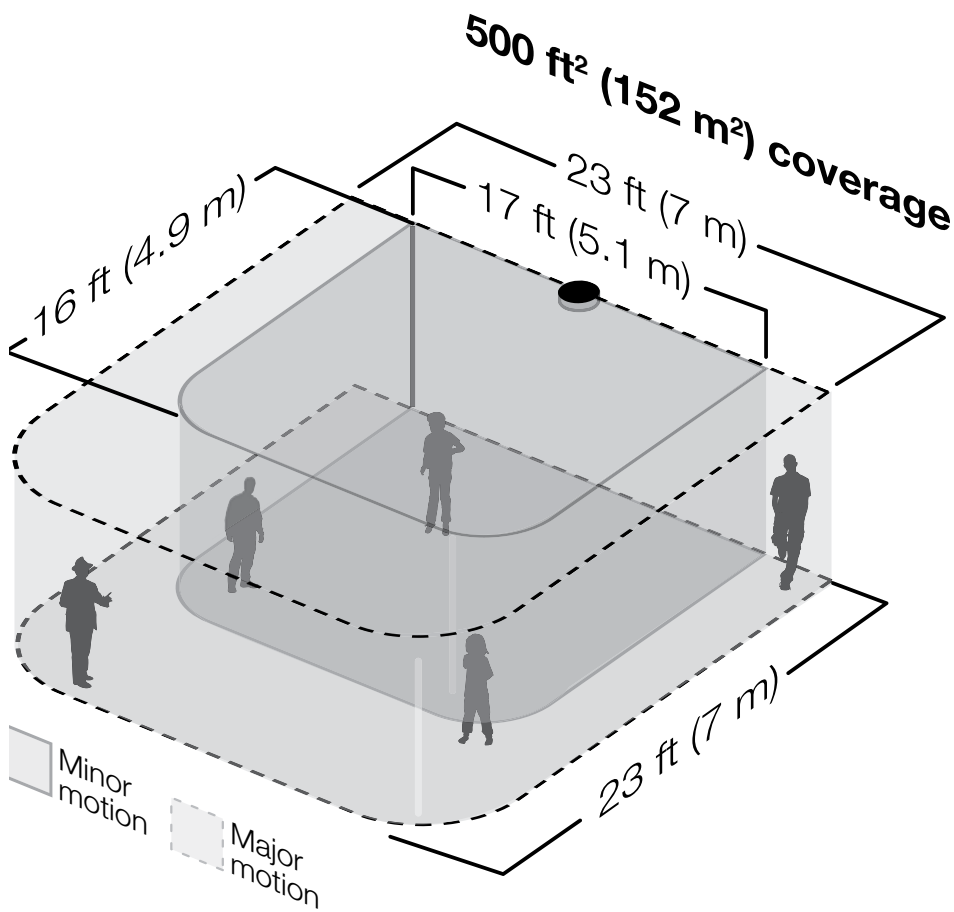
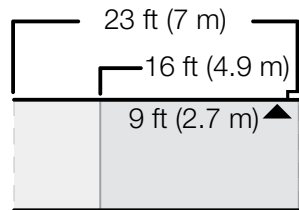



# Ultrasonic sensor coverage chart

**LOS-CUS models** (3 models available)

**Top view/Plan view**

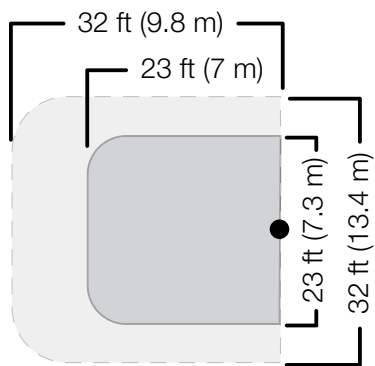

**Vertical view**

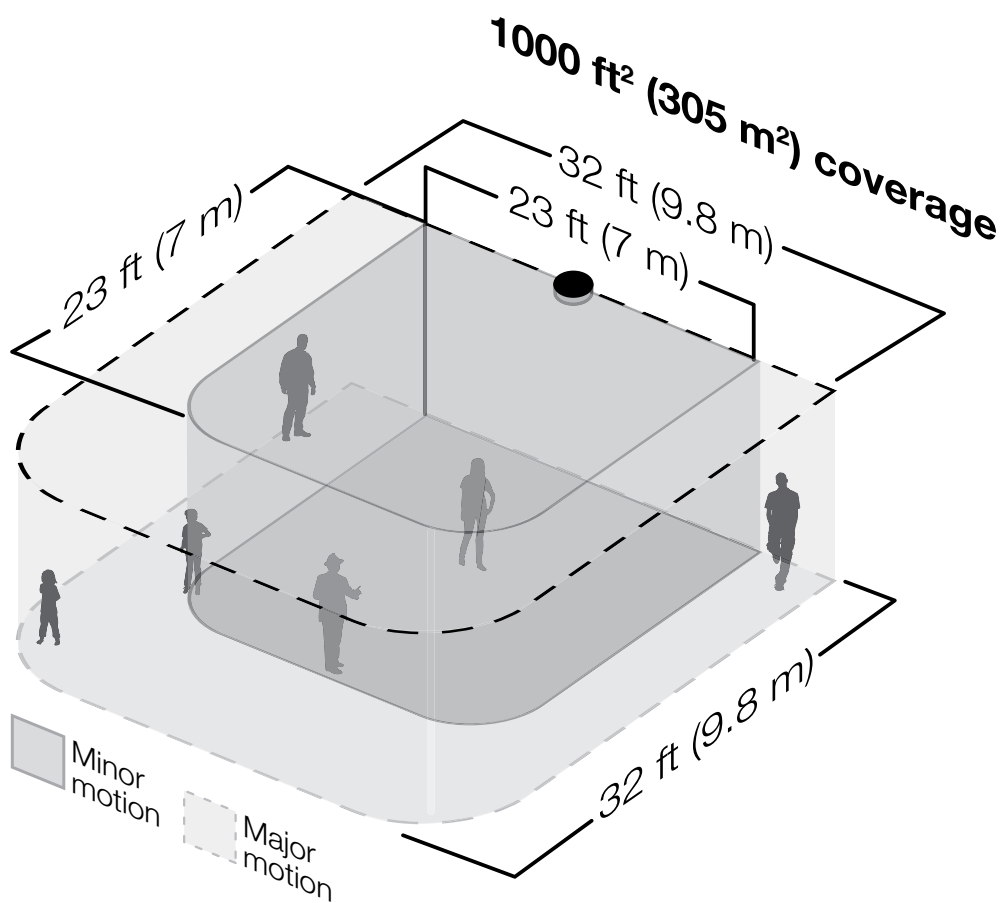
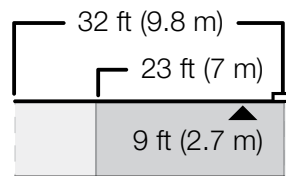

### Ultrasonic sensor coverage

#### LOS-CUS-2000 models

Top view/Plan view

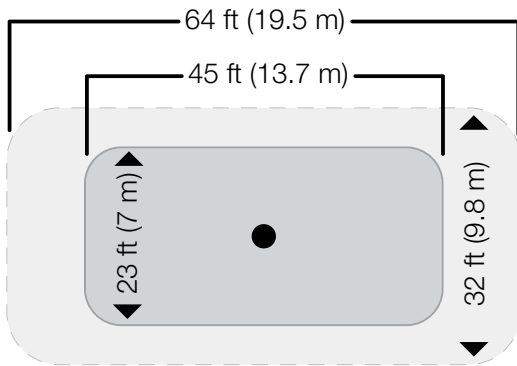

Vertical view

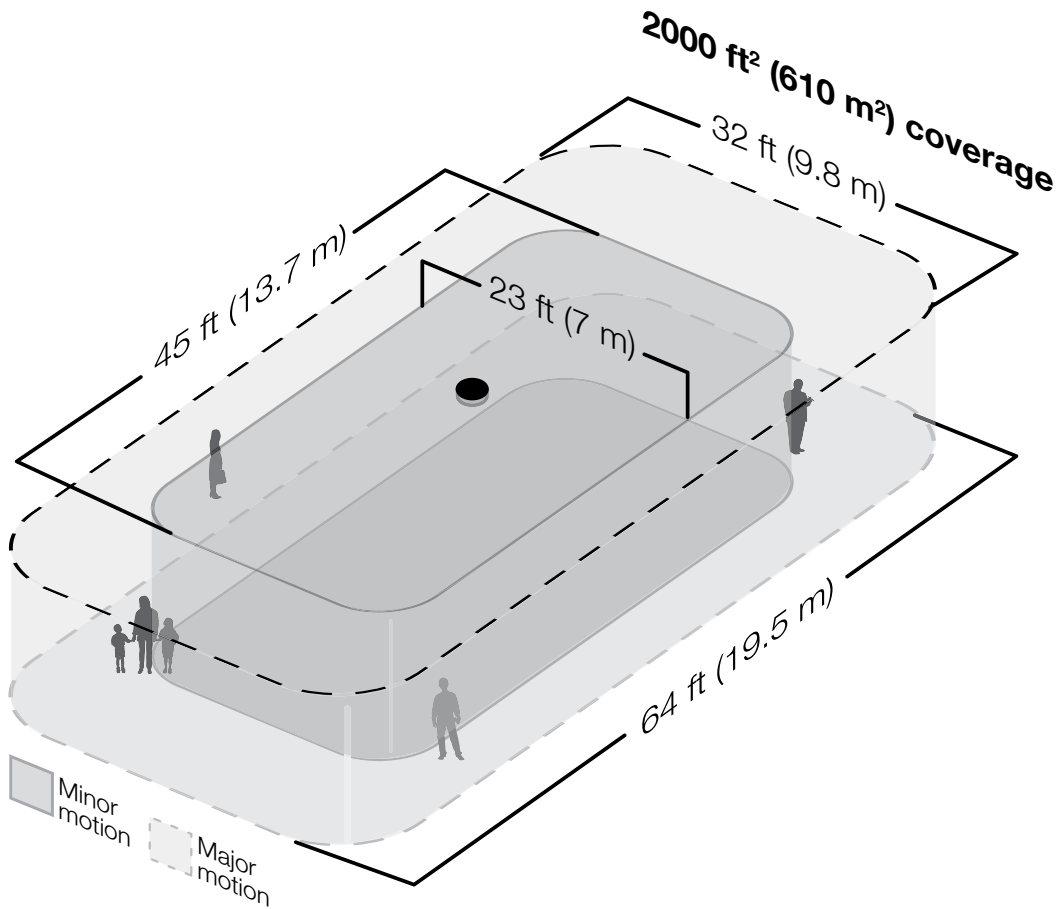
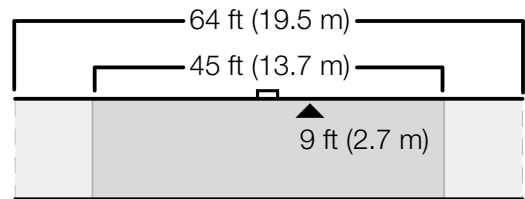

# PIR sensor coverage

## LOS-PIR-450 models

Top view/Plan view

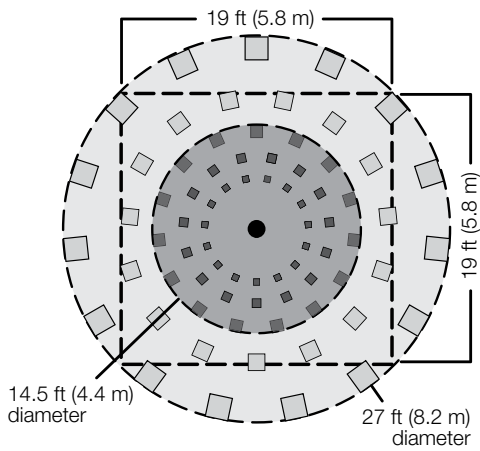

Vertical view

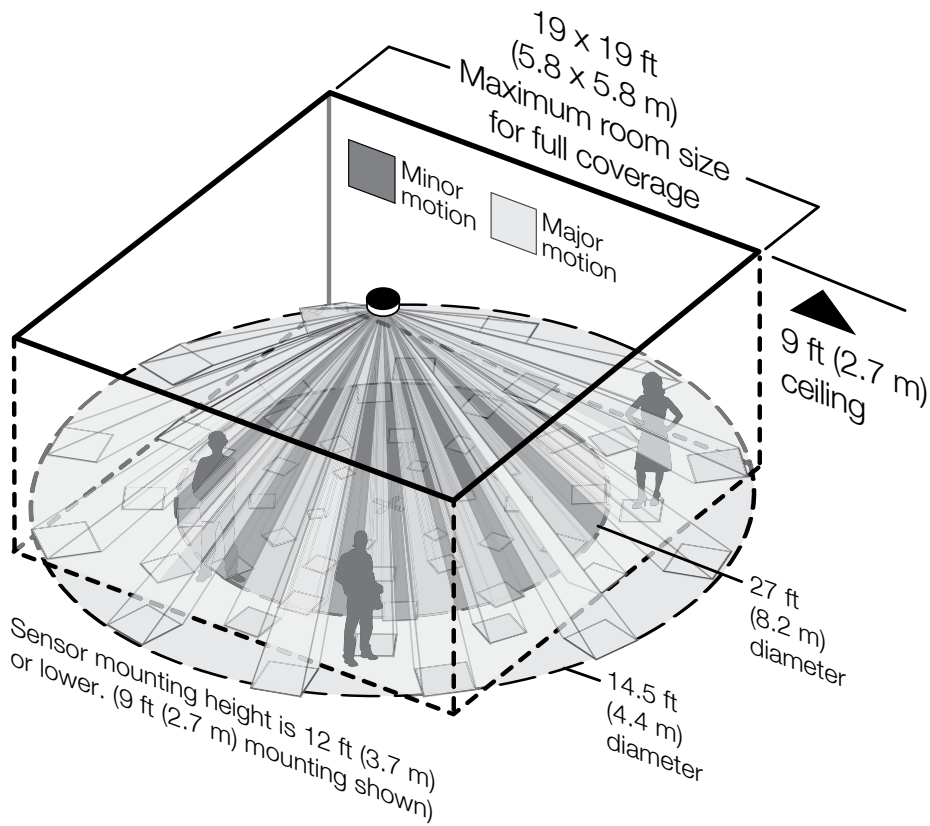
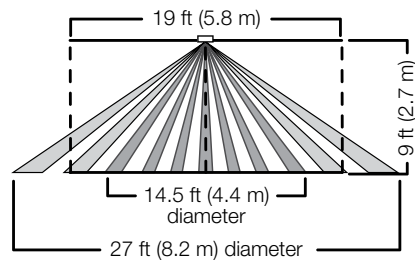

PIR sensor coverage

LOS-CIR-1500 models

Top view/Plan view

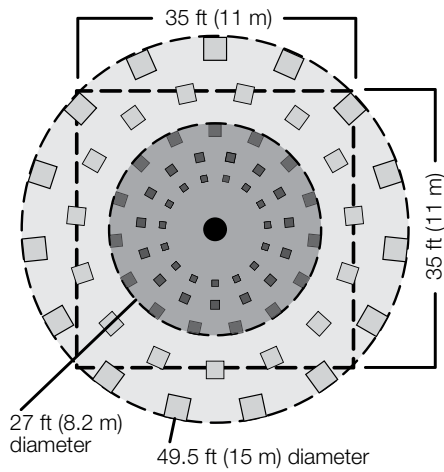

Vertical view

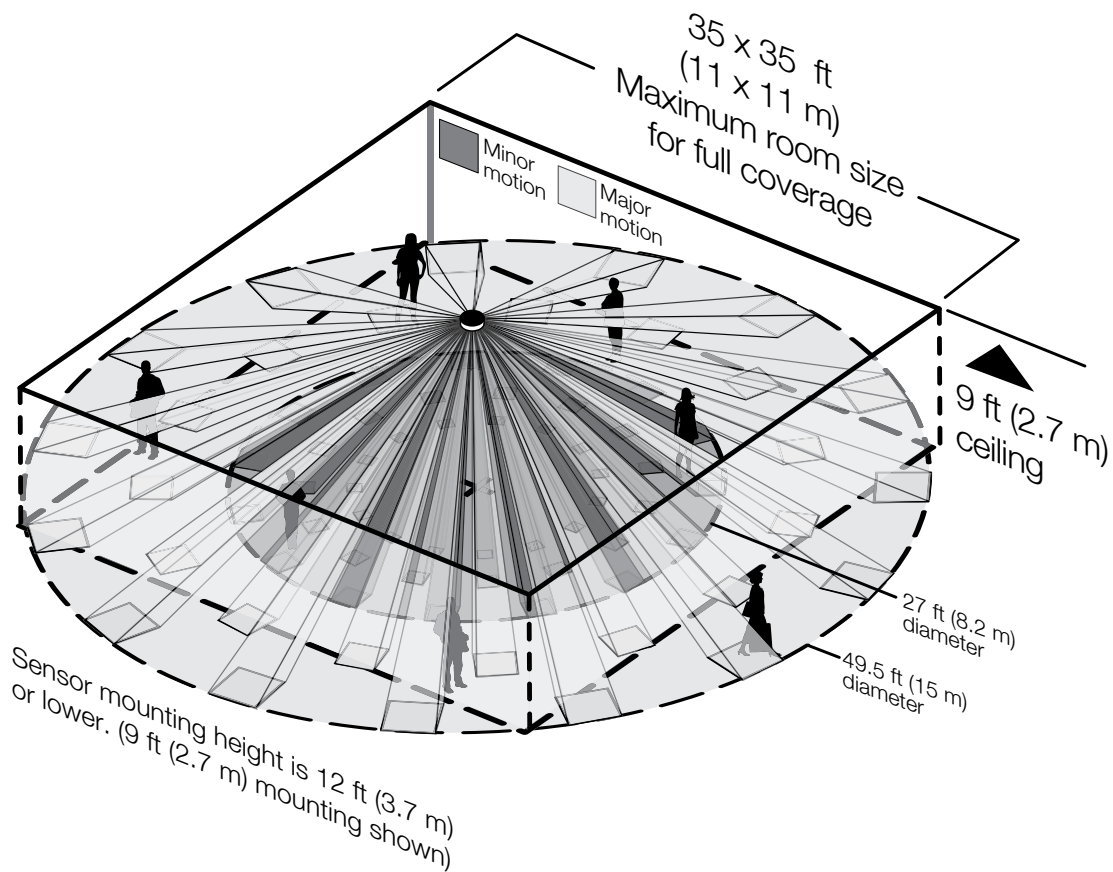
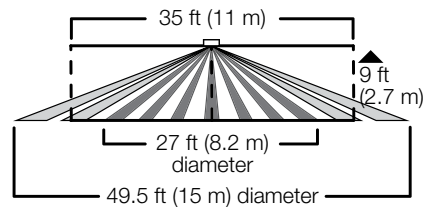





## Features and capacities

- Adjustable timeout – 4, 8, 16, or 30 minutes
- 360° field-of-view
- PIR motion detection
- For indoor use only, temperature:  
32° F–149° F (0° C–65° C)

## Dimensions and mounting

- Width: 4.4 in (112 mm)  
Height: 3.6 in (91 mm)  
Depth: 1.35 in (34 mm)
- Recommended mounting height: 30–45 ft  
(9.1–13.7 m) from floor
- Mounts through a ½ in NPT trade size  
knock-out to a junction box or a fixture

## Communication and wiring

- Operates via low-voltage (PELV) standard  
wired communication
- 20-24 V DC, class 2 low-voltage wiring (PELV)
- Uses two power draw units on the QS link,  
only if connected to the QS sensor module
- Power pack available



Shown actual size

## Model number

### Wired occupancy sensor

360° high bay, end-mount

occupancy/vacancy FHB140NP24V-CPN5190

180° high bay, end-mount

occupancy/vacancy  
LUT-WSP24V-180-CPN6112

360° high bay, surface-mount

occupancy/vacancy  
LUT-WSPSM24V-360-CPN6111

180° high bay, surface-mount

occupancy/vacancy  
LUT-WSPSM24V-180-CPN6111

# Sensor coverage

**Top view/Plan view**

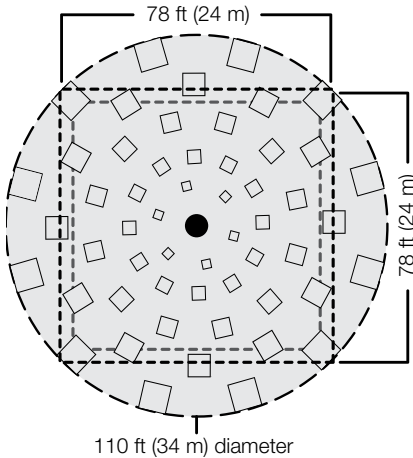

**Vertical view**

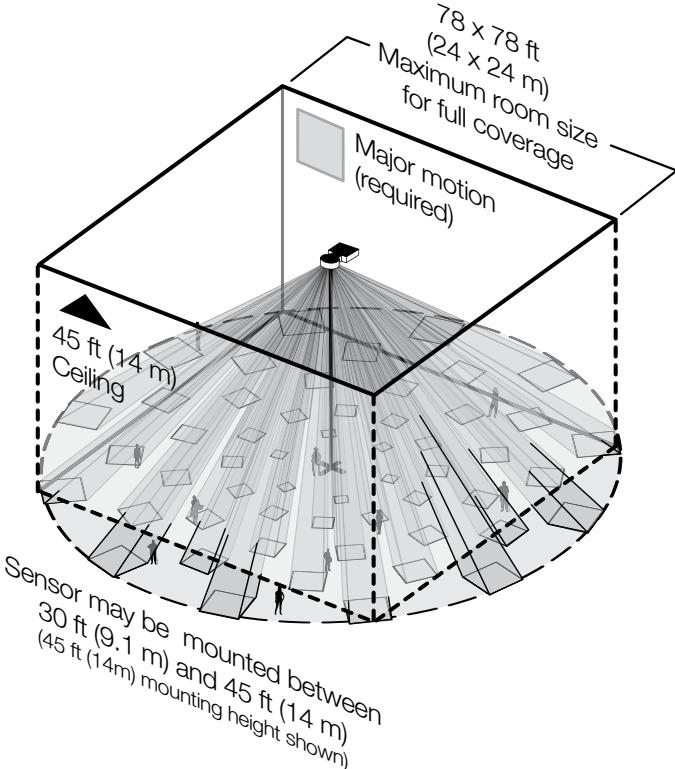
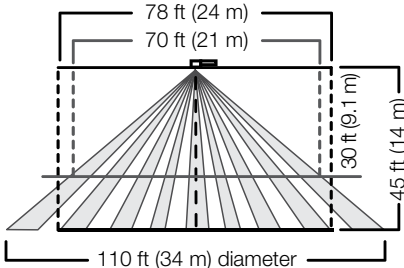



## Features and capacities

- Simple installation with no wiring
- Requires compatible receiving device (available separately)
- Occupancy/vacancy has auto-on/auto-off and manual on/auto-off
- Vacancy model has manual on/auto-off control to meet California Title 24 section 119(j) requirements
- Adjustable timeout — 1, 5, 15 or 30 minutes
- PIR motion detection with exclusive Lutron XCT™ technology for fine motion detection
- Battery included; 10-year battery life design
- For indoor use only, temperature: 32° F–104° F (0° C–40° C)

## Dimensions and mounting

- Width: 1.8 in (46 mm)  
Height: 4.35 in (110 mm)  
Depth: 1.35 in (34 mm)
- Recommended mounting height 6–8 ft (1.8–2.4 m) from floor
- Mount on wall within 60 ft (18 m) line-of-sight or 30 ft (9.1 m) through walls, of the receiving devices

## Communication

- Communicates via Lutron's reliable Clear Connect® RF technology to other Lutron wireless devices
- Operates at 434 MHz



Shown at 75% of actual size

## Model numbers

### Wireless occupancy/vacancy sensors

180° wall-mount (434 MHz)

occupancy/vacancy	LRF2-OWLB-P-WH
vacancy	LRF2-VWLB-P-WH

## Accessories

wall/hallway (swivel mount) sensors wire guard	WGLO
flexible armature mounting kit	LRF2-MTG-KIT-CPN5991

# 180° wall-mount sensor coverage

**Top view/Plan view**

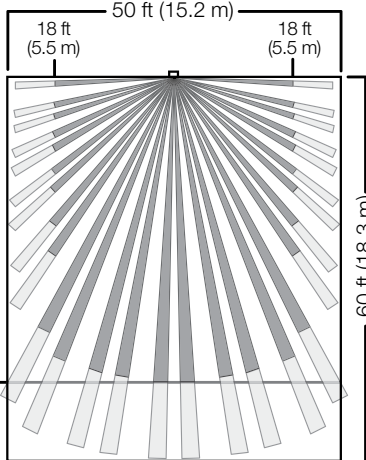

**Vertical view**

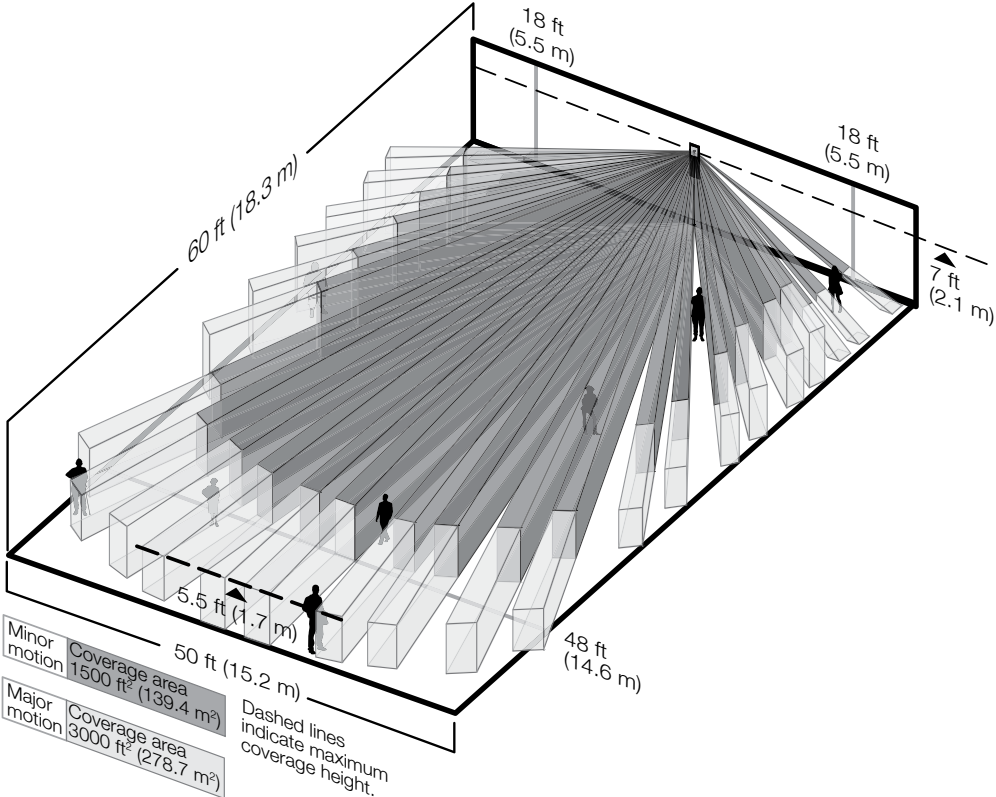
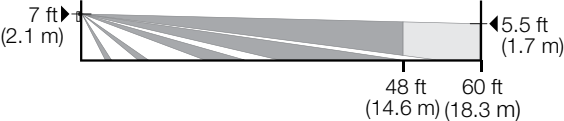

## Features and capacities

- Simple installation with no wiring
- Requires compatible receiving device (available separately)
- Occupancy/vacancy has auto-on/auto-off and manual on/auto-off
- Vacancy model has manual on/auto-off control to meet California Title 24 section 119(j) requirements
- Adjustable timeout — 1, 5, 15 or 30 minutes
- PIR motion detection with exclusive Lutron XCT™ technology for fine motion detection
- Battery included; 10-year battery life design
- For indoor use only, temperature: 32° F–104° F (0° C–40° C)

## Dimensions and mounting

- Width: 1.8 in (46 mm)  
Height: 4.35 in (110 mm)  
Depth: 1.35 in (34 mm)
- Recommended mounting height 6–8 ft (1.8–2.4 m) from floor
- Mount on wall within 60 ft (18 m) line-of-sight or 30 ft (9.1 m) through walls, of the receiving devices

## Communication

- Communicates via Lutron's reliable Clear Connect® RF technology to other Lutron wireless devices
- Operates at 434 MHz band



Shown at 75% of actual size

## Model numbers

### Wireless occupancy/vacancy sensors

90° corner-mount (434 MHz)

occupancy/vacancy	LRF2-OKLB-P-WH
vacancy	LRF2-VKLB-P-WH

## Accessories

wall/hallway (swivel mount) sensors wire guard	WGLO
flexible armature mounting kit	LRF2-MTG-KIT-CPN5991

# 90° corner-mount sensor coverage

**Top view/Plan view**

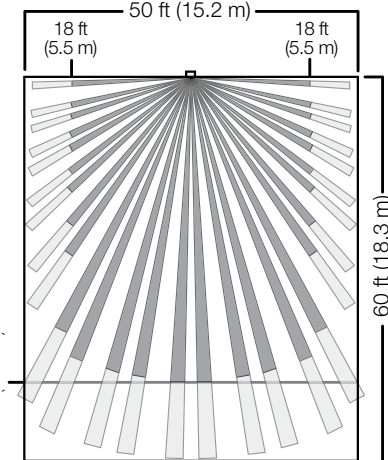

**Vertical view**

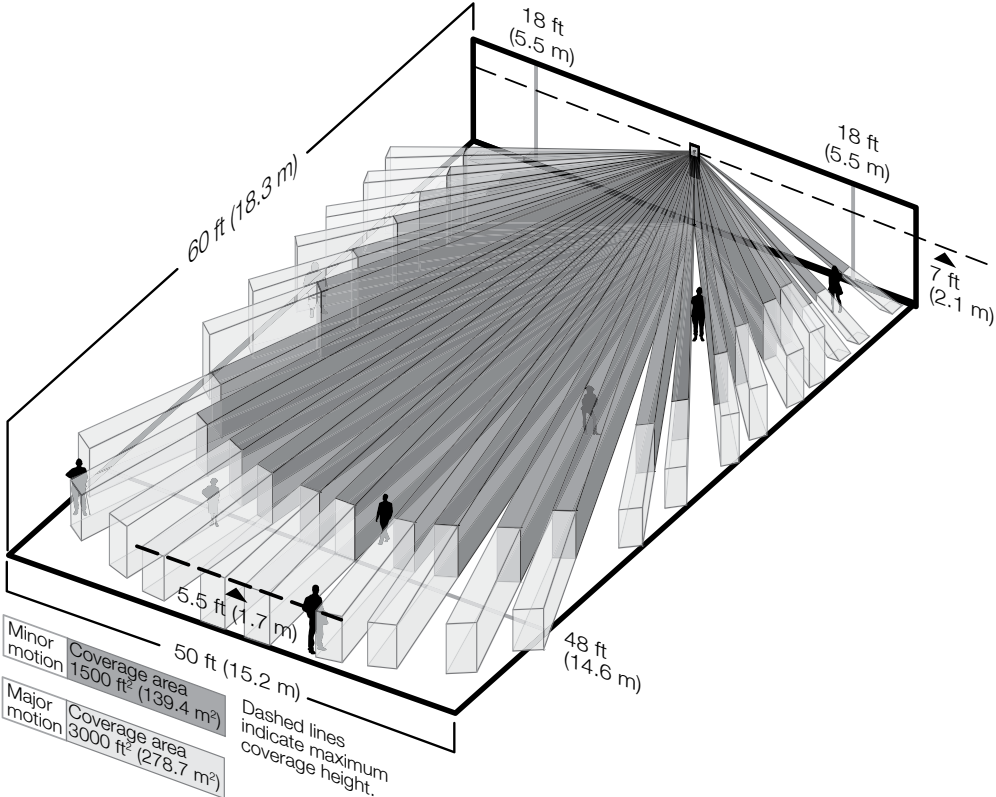
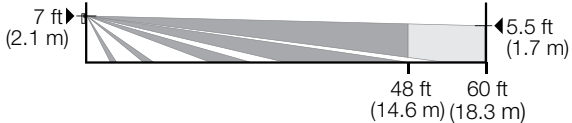

# Radio Powr Savr™ hallway occupancy/vacancy sensor

## Features and capacities

- Simple installation with no wiring
- Requires compatible receiving device (available separately)
- Occupancy/vacancy has auto-on/auto-off and manual on/auto-off
- Vacancy model has manual on/auto-off control to meet California Title 24 section 119(j) requirements
- Adjustable timeout — 1, 5, 15, or 30 minutes
- Battery included; 10-year battery life design
- For indoor use only, temperature: 32° F–104° F (0° C–40° C)

## Dimensions and mounting

- Width: 1.8 in (46 mm)  
Height: 4.35 in (110 mm)  
Depth: 1.35 in (34 mm)
- Recommended mounting height 6–8 ft (1.8–2.4 m) from floor
- Mount on wall within 60 ft (18 m) line-of-sight or 30 ft (9.1 m) through walls, of the receiving devices

## Communication

- Communicates via Lutron's reliable Clear Connect® RF technology to other Lutron wireless devices
- Operates at 434 MHz band



Shown at 75% of actual size

## Model numbers

### Wireless occupancy/vacancy sensors

hallway (434 MHz)

occupancy/vacancy	LRF2-OHLB-P-WH
vacancy	LRF2-VHLB-P-WH

## Accessories

wall/hallway (swivel mount)

sensors wire guard WGLO

flexible armature

mounting kit LRF2-MTG-KIT-CPN5991



# Hallway sensor coverage

## Top view/Plan view

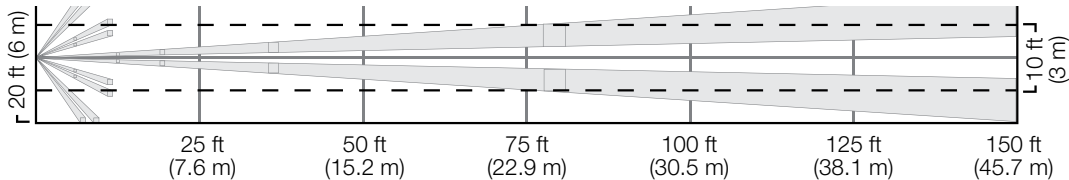

## Vertical view

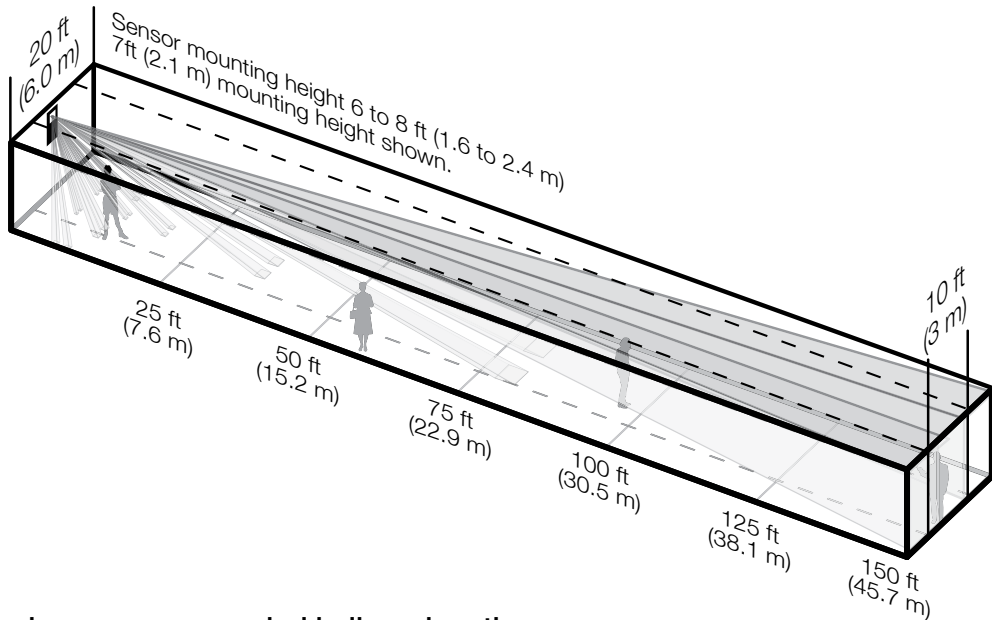
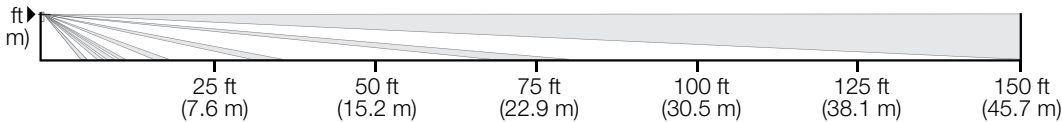

### Maximum recommended hallway length

Width of hall	Length of hall
6 ft (1.6 m) or less	50 ft (15.2 m)
8 ft (2.4 m)	100 ft (30.5 m)
10 ft (3.06 m) or more	150 ft (45.7 m)

\*Sensor mounting shown at 7 ft. (2.1 m); mounting height should be between 6 ft and 8 ft (1.6–2.4 m). Designed for mounting at the end of hallway with view down the length of hall; detection at longer distance is best for motion occurring at right angles to the sensor.

## Features and capacities

- Models available with PIR or dual-technology motion detection
- Self-adaptive sensors that automatically adjust sensitivity and timing
- Models available with additional dry contact closures
- 110° field-of-view
- Coverage of 1600ft<sup>2</sup> (488m<sup>2</sup>)
- For indoor use only, temperature: 32° F–104° F (0° C–40° C)

## Dimensions and mounting

- Width: 2.70 in (69 mm)  
Height: 5.25 in (133 mm)  
Depth: 3.90 in (99 mm)
- Recommended mounting height 8–12 ft (2.4–3.7 m) from floor
- Flexible base mounting on wall (or ceiling)

## Communication and wiring

- Operates via low-voltage (PELV) standard wired communication
- 20–24 V DC, class 2 low-voltage wiring (PELV)
- Uses two power draw units on the QS link, only if connected to the QS Sensor Module
- Power pack available



Shown actual size

## Model numbers

### Wired occupancy sensors

#### Dual-technology

1,600ft <sup>2</sup> (488m <sup>2</sup> ), 110°	LOS-WDT-WH
additional contact closure	LOS-WDT-R-WH

#### PIR

1,600ft <sup>2</sup> (488m <sup>2</sup> ), 110°	LOS-WIR-WH
---	------------



# Dual-technology sensor coverage

Top view/Plan view

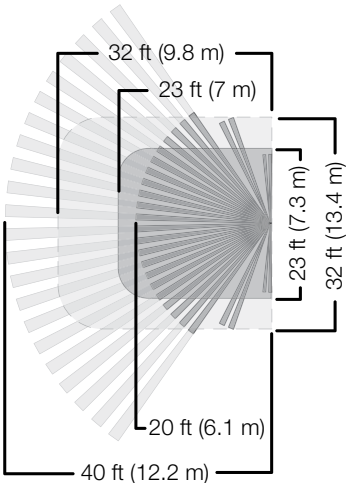

Vertical view

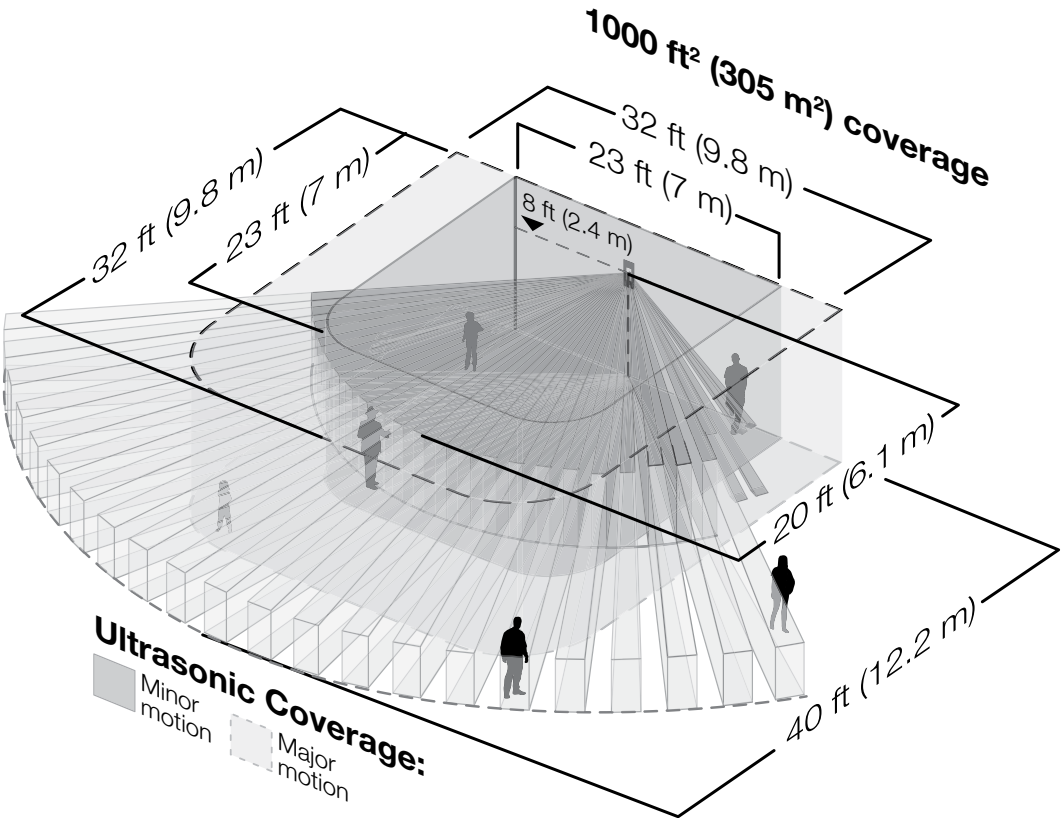
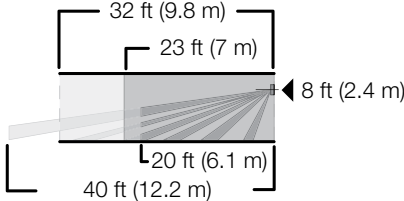

## PIR sensor coverage

Top view/Plan view

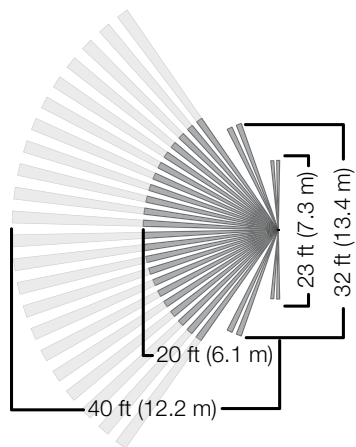

Vertical view

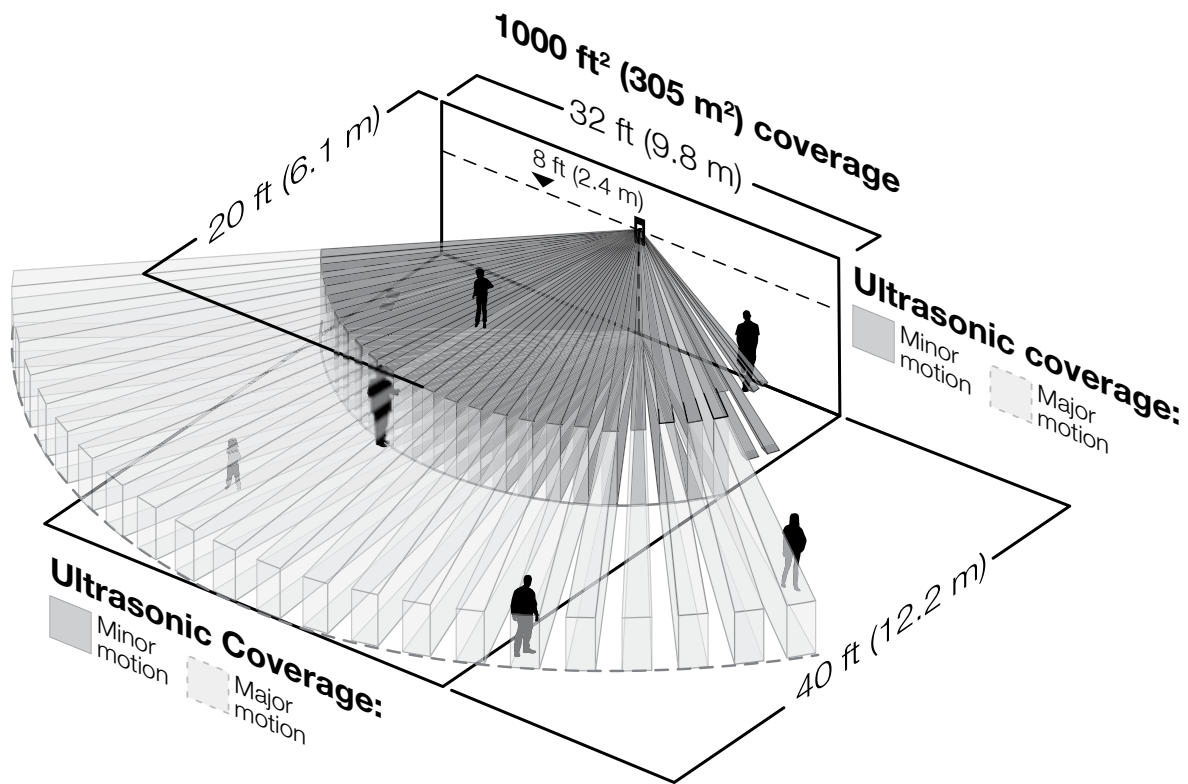
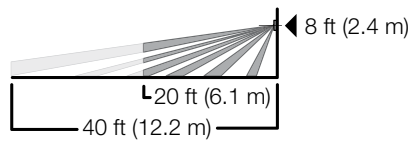



## Features and capacities

- Provides both 24 V DC power supply to operate sensors and 16 A line-voltage relay to control load
- Required for LOS-C and LOS-W series occupancy sensors used as a standalone lighting control
- Auxiliary relay allows for control of multiple circuits or load types
- 120–277 or 347 VAC power input at 50/60 Hz
- 24 V DC, 100 mA power output
- Plenum rated
- Switch rating:
  - 20A: 120/230/277V ballast
  - 16A: All lighting loads including (but are not limited to) incandescent, MLV, ELV, resistive, inductive
  - 15A: 347V ballast
- Supports up to three occupancy sensors/ auxiliary relays

## Dimensions and mounting

- Width: 3.69 in (94 mm)  
Height: 2.33 in (59 mm)  
Depth: 1.36 in (35 mm)
- Mounts through a ½ in NPT trade size knock-out to a junction box or to a fixture. Can also be mounted inside a standard 4 in x 4 in junction box.

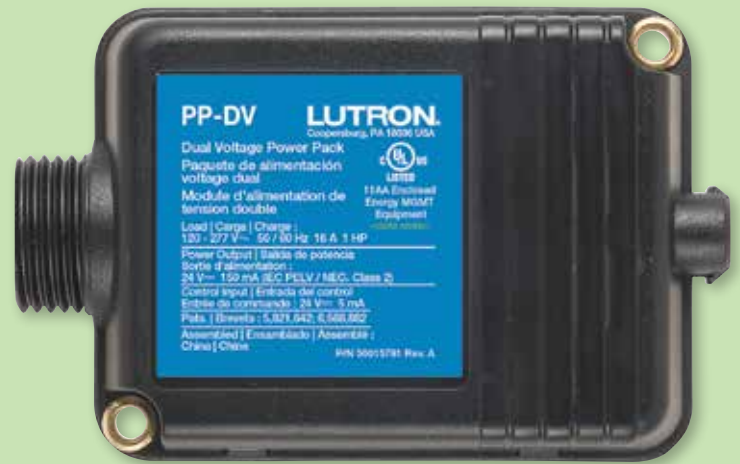

Shown actual size

## Model numbers

### power packs

120–277 VAC	PP-DV
120–277 VAC w/manual input	PP-DV-M
347 VAC	PP-347H

### auxiliary relay

120/230/277/347 VAC	PP-SH
---------------------	-------



## Wiring diagram

### One to three sensors with power packs

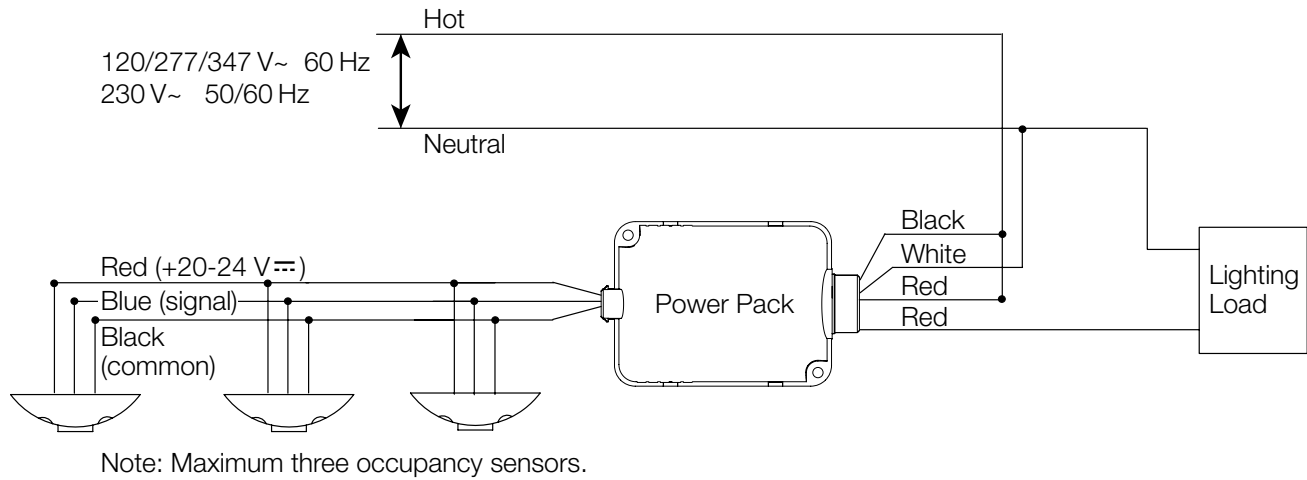

### Switching multiple loads with auxiliary with power packs

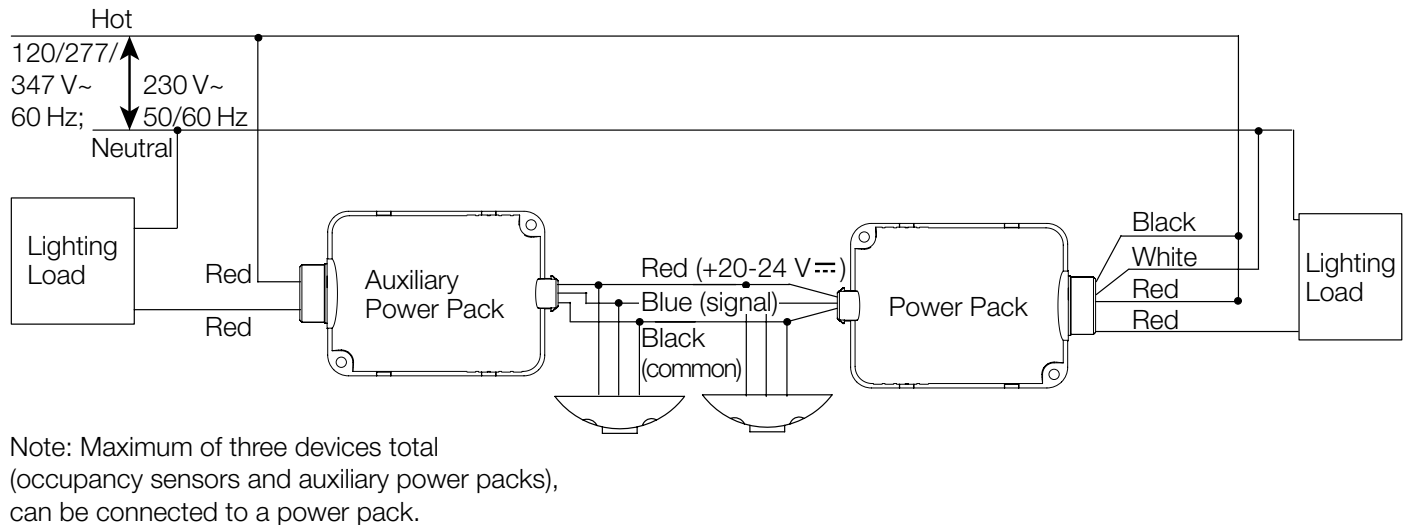

## Wire guards

Heavy-duty coated wire guards protect sensors from destructive strikes. Wire guards do not reduce sensor coverage.

Mounting clips are included. Color: White.

**WGWS** – In-wall-mounted sensor wire guard, 6.25”H x 4.0”W x 2.25”

---

**WGLO** – Wall/hallway (swivel mount) sensors wire guard, 7.0”H x 5.75”W x 4.5”D

---

**WGOMNI** – Ceiling-mount wire guard for OMNI sensors, 7.0”W x 3.25”D (circular guard)

---

**STI-9618** – Corner-mount wire guard for LRF2-O(K/W/H)L2B-P, 4.62”H x 5.37” W x 3.0”D

---

**OPE-IRONLY-CPN3688** – NEMA 4 rated enclosure for ceiling-mount IR sensors only

---

## Flexible armature mounting kit

**LRF2-MTG-KIT-CPN5991** – Use this kit to mount a standard Lutron wall-mount sensor to a ceiling or right angle application.

The ball and clamp design lets you position the sensor in a specific direction, providing a greater ceiling-mount viewing range or specific limited viewing in a flat surface-mount application.

The flexible mounting brackets let you mount sensors at right angles and at higher levels to increase the coverage area (perfect for warehouse applications).





# Compatible products

Sensor configuration	Product numbers	Maestro Wireless®	Energi TriPak®	GRAFIK Eye® 3000	GRAFIK Eye QS	GRAFIK Eye QS Wireless
<b>Ceiling mount models</b>						
Radio Powr Savr™	LRF2-OCR2B-P-WH	•	•		◇	•
	LRF2-VCR2B-P-WH	•	•		◇	•
LOS-C series	LOS-CDT-2000-WH			†	•	•
	LOS-CDT-2000R-WH			†	•	•
	LOS-CDT-1000-WH			†	•	•
	LOS-CDT-1000R-WH			†	•	•
	LOS-CDT-500-WH			†	•	•
	LOS-CDT-500R-WH			†	•	•
	LOS-CUS-2000-WH			†	•	•
	LOS-CUS-1000-WH			†	•	•
	LOS-CUS-500-WH			†	•	•
	LOS-CIR-1500-WH			†	•	•
	LOS-CIR-450-WH			†	•	•
High bay	FHB140NP24V-CPN5190			†	•	•
<b>Wall mount models</b>						
Radio Powr Savr	LRF2-OWLB-P-WH	•	•		◇	•
	LRF2-VWLB-P-WH	•	•		◇	•
	LRF2-OKLB-P-WH	•	•		◇	•
	LRF2-VKLB-P-WH	•	•		◇	•
	LRF2-OHLB-P-WH	•	•		◇	•
	LRF2-VHLB-P-WH	•	•		◇	•
LOS-W series	LOS-WDT-R-WH			†	•	•
	LOS-WDT-WH			†	•	•
	LOS-WIR-WH			†	•	•

◇ Requires QS sensor module for wireless sensors

† Requires wired power packs and/or I/O device

Energi Savr Noder™	Stanza®	RadioRA® 2	Homeworks®	Homeworks QS	GRAFIK Eye 4000	XPS	LCP128	GRAFIK 7000™	Quantum®
◇		•		•					◇
◇		•		•					◇
•	†	†	†	†	†	†	†	†	•
•	†	†	†	†	†	†	†	†	•
•	†	†	†	†	†	†	†	†	•
•	†	†	†	†	†	†	†	†	•
•	†	†	†	†	†	†	†	†	•
•	†	†	†	†	†	†	†	†	•
•	†	†	†	†	†	†	†	†	•
•	†	†	†	†	†	†	†	†	•
•	†	†	†	†	†	†	†	†	•
•	†	†	†	†	†	†	†	†	•
•	†	†	†	†	†	†	†	†	•
•	†	†	†	†	†	†	†	†	•
◇		•		•					◇
◇		•		•					◇
◇		•		•					◇
◇		•		•					◇
◇		•		•					◇
◇		•		•					◇
•	†	†	†	†	†	†	†	†	•
•	†	†	†	†	†	†	†	†	•
•	†	†	†	†	†	†	†	†	•

## Sensor layout and tuning service

Installing sensors can be an inexact science, and sensor fine-tuning is best performed after the space is fully occupied, furniture is in place, and the HVAC system is balanced to the environment.

Lutron offers a sensor layout and tuning service to ensure that our sensors are installed and calibrated to perform as intended.

When the Lutron Sensor Layout and Tuning Service is purchased, we'll inform the installing contractor where to place the sensors (both wired and wireless). During system startup, we may provide recommendations to the installing contractor regarding sensor location in accordance with the installation instructions. We'll also provide a rough sensor calibration. Once the building is occupied, we'll return, up to two times, to perform sensor fine-tuning.

To learn more about this service, please call 1.800.523.9466 or email [LSCscheduling@lutron.com](mailto:LSCscheduling@lutron.com).

For specification information, see Lutron document LSC-SENS-LT, PN 360-1235.

[Lutron.com/occsensors](http://Lutron.com/occsensors)



Lutron Electronics Co., Inc.  
7200 Suter Road  
Coopersburg, PA 18036-1299

World Headquarters 1.610.282.3800  
Technical Support 1.800.523.9466 (Available 24/7)  
Customer Service 1.888.LUTRON1 (1.888.588.7661)

© 07/2014 Lutron Electronics Co., Inc. | P/N 368-3197 REV A

